

Daimler HDEP

Heavy-Duty Engine Platform



OM 470/MTU 6R 1100 C

OM 471/Detroit Diesel DD13/MTU 6R 1300 C

OM 472/Detroit Diesel DD15

OM 473/Detroit Diesel DD16/MTU 6R 1500

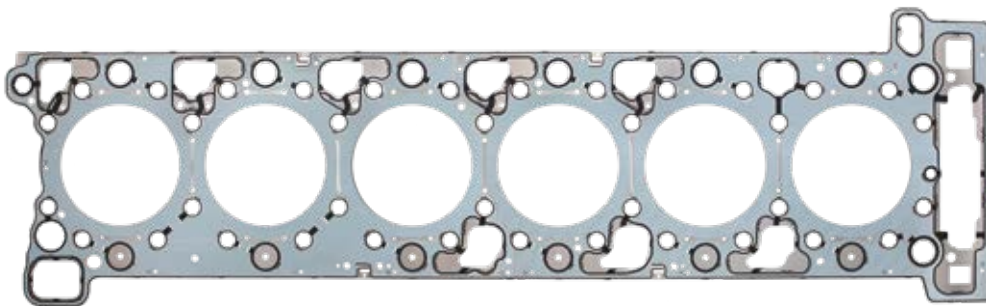

Das Original

Heavy-Duty Engine Platform

Mercedes-Benz / Detroit Diesel / MTU /
Fuso-Mitsubishi

Displacement: 10.7 L, 12.8 L, 14.8 L, 15.6 L

2007 marked the global introduction of the engine platform for heavy duty trucks and was associated with the development of new designs for engine gaskets and never seen before production processes, especially for cylinder-head gaskets with the aim of long-term durability.

Since 1927 ElringKlinger, engaged in the series delivery for Mercedes-Benz engine gaskets and was able, through extensive research and development, to bring its know-how to this engine platform. The manufacturing process takes place at ElringKlinger's 44 production sites all around the world.

The main reasons for this worldwide versatile engine platform were the predictable high investments to comply with the European emission standard Euro VI and for the legal regulations for North America, according to EPA 7 and EPA 10.

For the V-engines, used for decades in the heavy-duty trucks mainly within Europe, it became obvious that their time had come to an end. Overhead camshafts and the positioning of auxiliary components, such as turbocharger or EGR (Exhaust Gas Recirculation), made this change imperative.

Cylinder-head gaskets for one-piece cylinder-heads became globally necessary and posed a huge technical challenge. Increased ignition pressure, low bolt forces and a pursued long-term durability of 1.2 million kilometers in the case of the OM 471 (12.8 L) engine. Moreover, there was the need to develop a cost-effective production of the cylinder-head gasket and to warrant the processes. The result is a multi-layer steel elastomer gasket. The developed gasket design could best be described as a puzzle.

On one hand the cylinder-head gasket is composed of three single metal layers in the centre, each with direct injected elastomer elements. Their specific sealing lip design allows for a low sealing pressure level. On the other hand there are two separate cover layers that seal the combustion chamber towards the engine block and cylinder-head. The embossed steel beads allow a consistent high level of sealing pressure to minimize the sealing gap oscillations. This one-of-a-kind technology is applied on all engine displacements.





Seal kit for injector nozzles
OM 470 / 471 / 472 / 473
🔧 841.360
460 070 09 87



Inspection set diesel radiator
OM 470 / 471 / 472 / 473
🔧 340.330
470 090 05 79

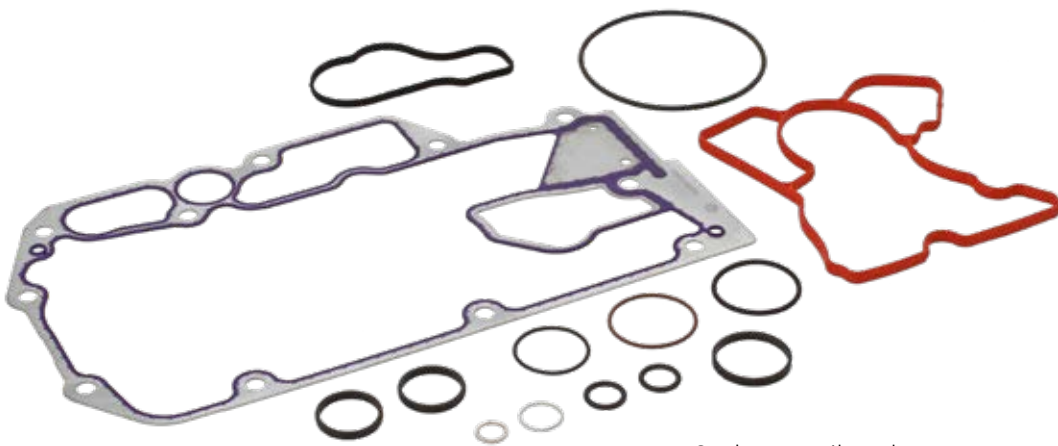

Gasket set oil cooler
OM 471
🔧 840.870

OM 470/MTU 6R 1100 C



Cylinder head gasket
OM 470
Ø 130 mm
727.894
470 016 09 20

OM 471/Detroit Diesel DD13/MTU 6R 1300 C

Cylinder head gasket
OM 471
Ø 133 mm
380.060
471 016 07 20

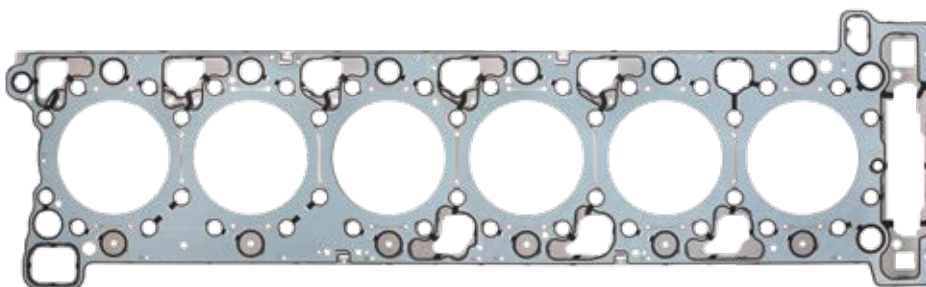
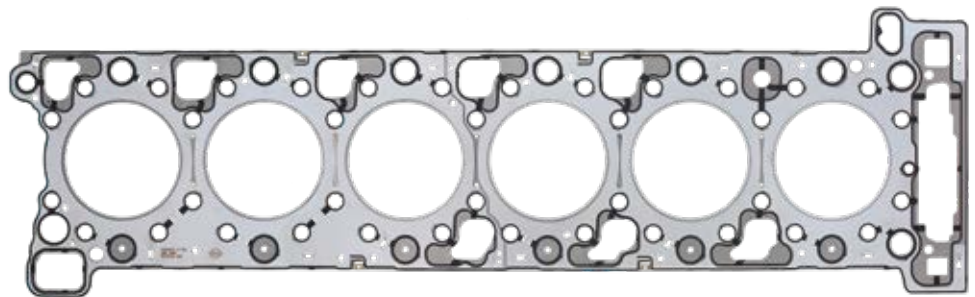

Cylinder head gasket
OM 471
Ø 137 mm, cylinder liner
fitted with fire ring
601.800
471 016 12 20

OM 472/Detroit Diesel DD15

OM 473/Detroit Diesel DD16/MTU 6R 1500

Cylinder head gasket
OM 472/OM 473
Ø 140 mm
396.472
472 016 13 20

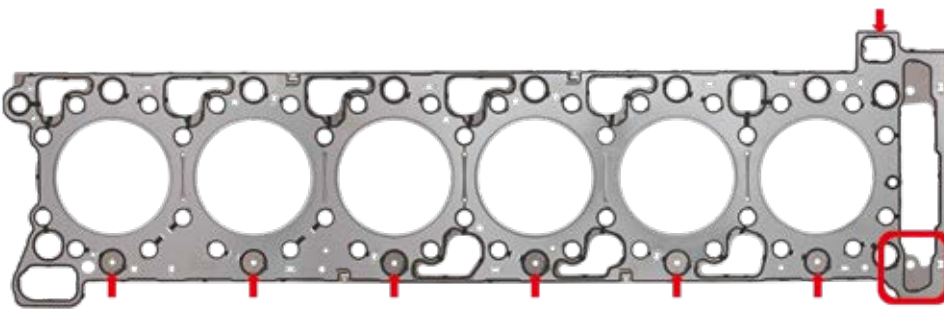
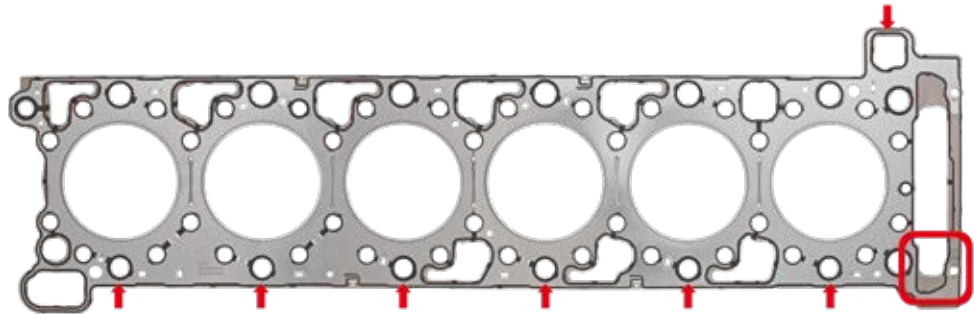

Cylinder head gasket
OM 472 / OM 473
Ø 140 mm
574.862
472 016 14 20

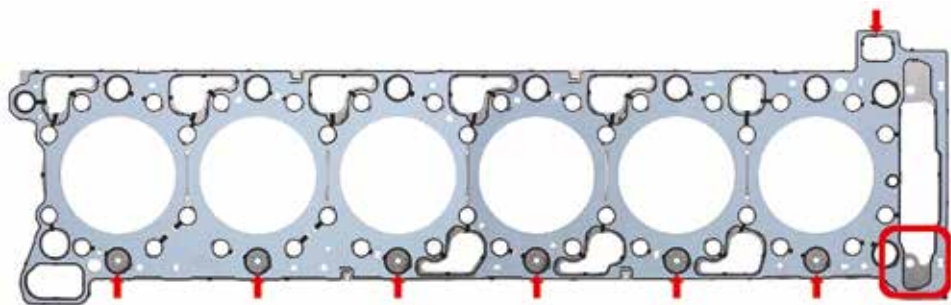

Cylinder head gasket OM 472 / OM 473
Ø 143,6 mm, cylinder liner fitted with fire ring
896.235
472 016 18 20

Mercedes-Benz



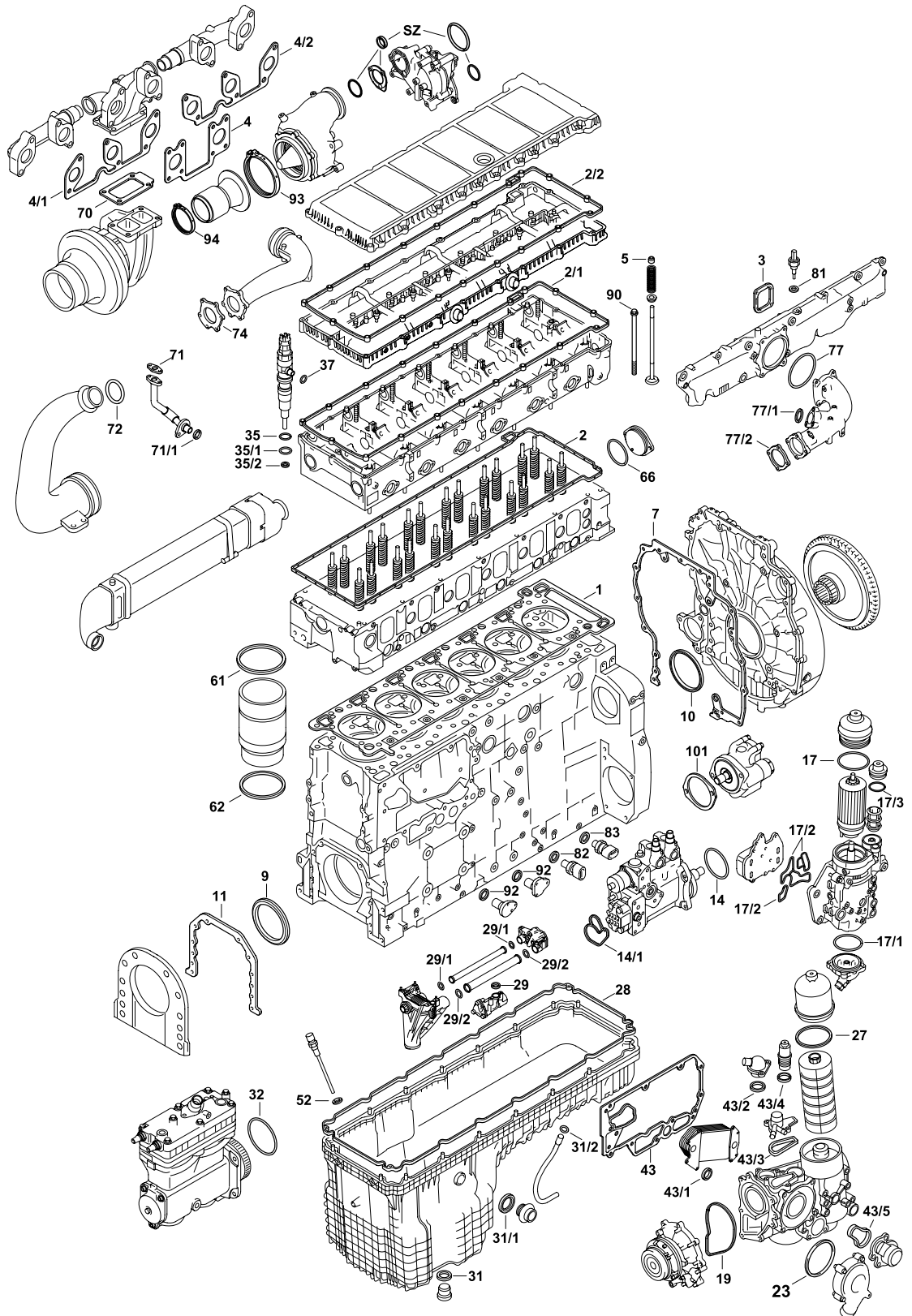



















OM 470





470.903 | 904 | 906 | 907 | 908 | 910 | 913 | 914 | 915 | 917 | 921 | 922 | 923

MTU 6R 1100 C

			#		
	356.031	1x	-	-	  
	356.041	1x	-	-	 
	356.050	1x	-	-	 
	852.570	1x	-	M14x2x186	Kit
	524.930	1x	-	-	Kit
	340.330	1x	470 090 05 79	-	Inspection set diesel radiator
	972.680	1x	-	-	Gasket set waste gas turbine
	840.740	1x	-	-	Gasket set oil cooler
	708.540	1x	-	-	Crankcase ventilation seal set
	841.360	1x	460 070 09 87	-	Seal kit, injector nozzle
	654.270	1x	470 053 01 58	-	Kit
	076.240	1x	-	-	Cylinder liner seal kit
1	727.894	1x	470 016 09 20	-	-
2	730.171	1x	470 016 02 80	-	-
2/1	904.920	1x	470 016 00 21	-	-
2/2	904.920	1x	470 016 00 21	-	-
2/2	470.590	1x	470 016 03 21	-	-
3	906.690	6x	472 098 00 80	-	-
4	339.630	3x	470 142 01 80	-	-
4/1	510.630	1x	470 142 01 80	-	-
4/2	510.640	1x	470 142 02 80	-	-
5	906.760	24x	470 053 01 58	9x13,4/16,1x15,2 FPM	-
7	340.140	1x	470 015 07 80	-	-
9	905.480	1x	014 997 98 46	100x130x14 AW/SP RD FPM	-
10	003.770	1x	015 997 49 46	138x163x12 ASW LD PTFE/ACM	-
11	364.457	1x	472 011 02 80	-	-
14	002.920	1x	017 997 89 45	100x3,1 FPM RD	-
14/1	588.210	1x	000 091 08 60	-	-
17	339.590	1x	021 997 33 45	62,75x3 FPM RD	-
17	339.540	1x	021 997 32 45	117x4 FPM RD	-
17/1	339.530	1x	024 997 52 45	121,35x4,5 FPM RD	-

Mercedes-Benz

OM 470

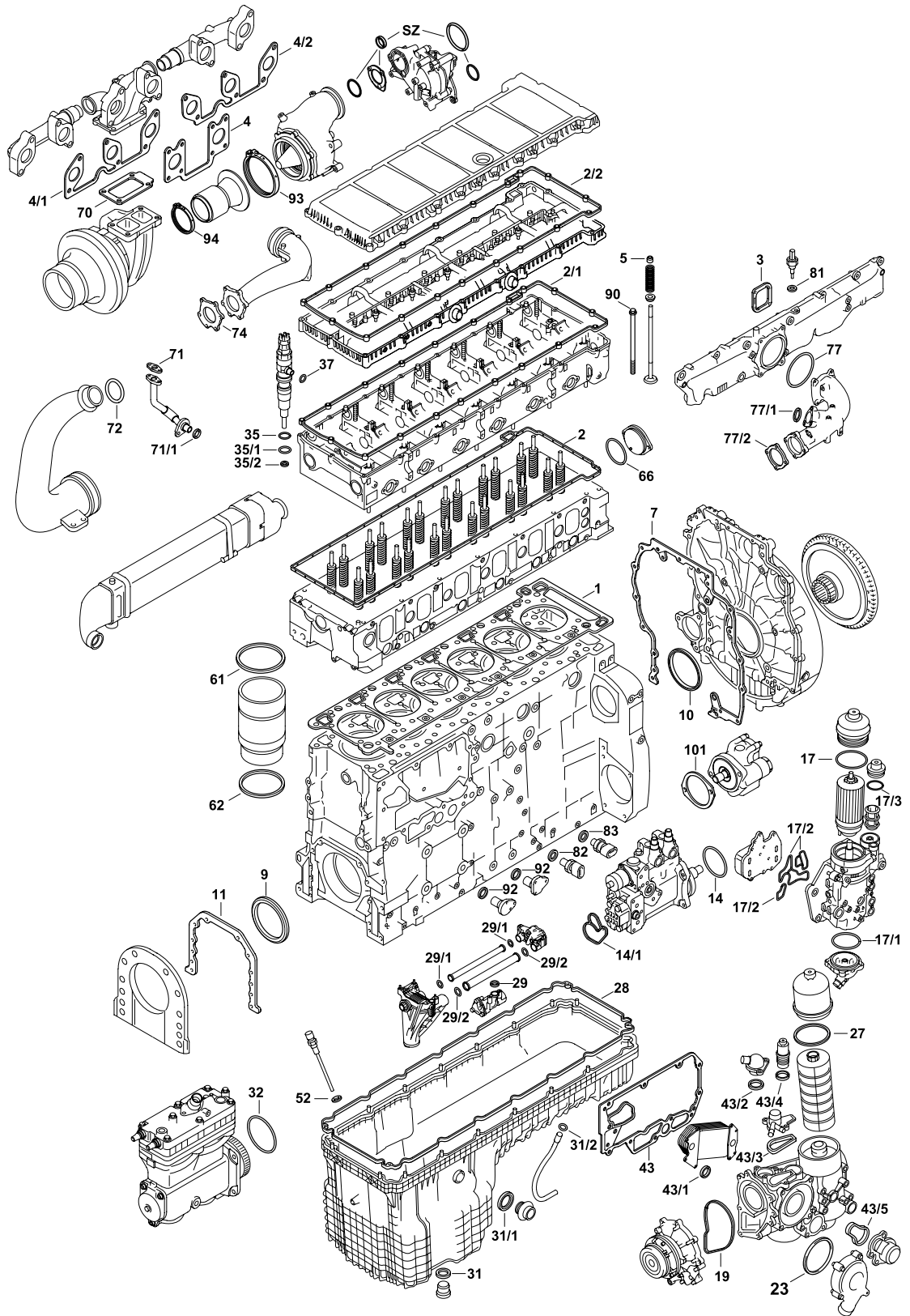



470.903 | 904 | 906 | 907 | 908 | 910 | 913 | 914 | 915 | 917 | 921 | 922 | 923

MTU 6R 1100 C

			#	  	
17/1	653.980	1x	026 997 71 45	110,7x3,1 FMQ RD	-
17/2	340.330	1x	470 090 05 79	-	-
17/3	339.590	1x	021 997 33 45	62,75x3 FPM RD	-
19	004.010	1x	472 201 00 80	-	-
23	004.030	1x	472 203 00 80	-	-
27	794.570	1x	470 997 05 45	129x4,2 ACM RD	-
28	789.060	1x	470 014 01 22	Elastomer/Rubber/Caoutchouc/ Goma	-
28	732.431	1x	470 014 03 22	-	
28	340.400	1x	470 014 04 22	Elastomer/Rubber/Caoutchouc/ Goma	-
29	003.190	1x	472 188 00 80	-	-
29/1	003.050	2x	472 187 08 80	38,3x48x6,2 FPM PR	-
29/2	003.040	2x	472 187 09 80	48,3x58x6,2 AEM PR	-
31	128.503	1x	000000 001085	22x27x1,5 CU A	-
31/1	478.740	1x	024 997 89 45	33,6x50x2 FE/ACM A	-
31/2	003.030	1x	024 997 88 45	22x29x1,5 FE/ACM A	-
32	651.250	1x	023 997 71 45	125,2x3,1 FPM RD	-
35	002.840	6x	017 997 88 45	29x3,5 FPM RD	-
35/1	002.820	6x	017 997 87 45	29,4x2,65 FPM RD	-
35/2	124.870	6x	906 017 02 60	7x15,1x1,5 CU PR	-
37	002.870	6x	017 997 86 45	13x2 FPM RD	-
43	339.850	1x	470 184 10 80	-	-
43/1	478.300	2x	470 188 08 80	-	-
43/2	340.100	1x	470 997 01 45	39,8x3,5 HNBR RD	-
43/3	340.090	1x	470 203 08 80	-	-
43/4	340.110	1x	470 997 04 45	50,75x3,5 HNBR RD	-
43/5	339.870	1x	470 184 08 80	-	-
52	003.030	1x	024 997 88 45	22x29x1,5 FE/ACM A	-
52	805.020	1x	000000 001072	20x26x1,5 CU/ZNN A	-
61	339.500	6x	024 997 43 45	134,45x3,8x3,5 FPM PR	-
62	339.500	6x	024 997 43 45	134,45x3,8x3,5 FPM PR	-
66	906.670	1x	472 997 08 45	89,2x4 ACM RD	-
70	339.640	1x	470 096 01 80	-	-

Mercedes-Benz

OM 470

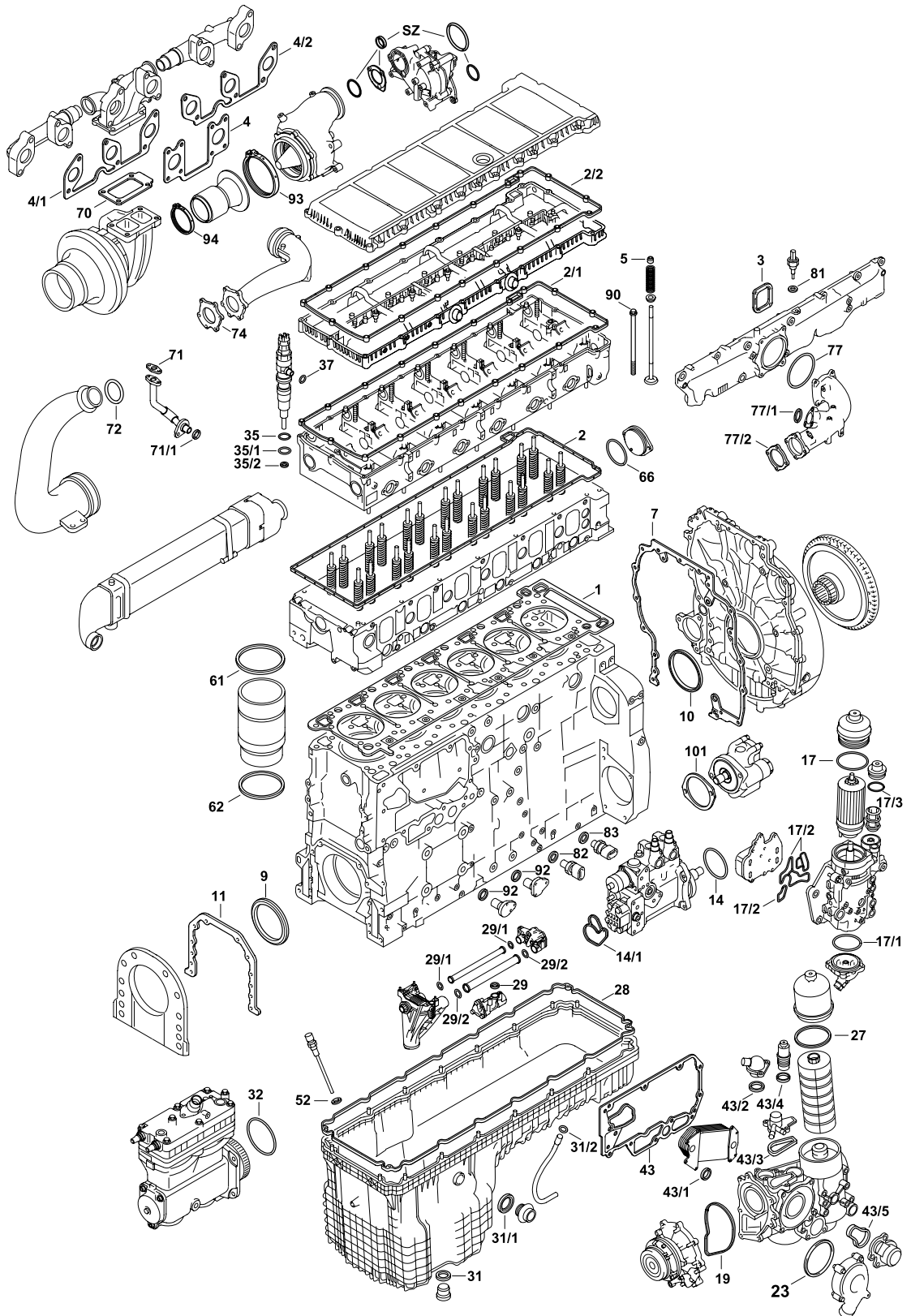



470.903 | 904 | 906 | 907 | 908 | 910 | 913 | 914 | 915 | 917 | 921 | 922 | 923

MTU 6R 1100 C



71	527.090	1x	541 187 00 80	-	-
71/1	003.730	1x	018 997 31 45	21,7x5 ACM RD	-
72	491.970	1x	025 997 43 48	58x3,5 FPM RD	-
74	656.330	1x	471 142 06 80	-	-
77	734.220	1x	470 098 01 80	-	-
77/1	303.620	1x	472 997 02 45	-	-
77/2	906.710	1x	460 098 01 80	-	-
77/2	303.610	1x	472 098 04 80	-	-
81	804.980	1x	000000 001069	14x20x1,5 CU/ZNN A	-
82	804.980	1x	000000 001069	14x20x1,5 CU/ZNN A	-
83	804.990	1x	000000 001070	16x22x1,5 CU/ZNN A	-
90	852.570	1x	470 016 00 69	M14x2x186	Kit
92	816.957	4x	022 997 25 48	17x1,8 FPM RD	-
93	535.540	1x	000 995 82 02 002 995 15 02	-	-
94	535.550	1x	000 995 81 02 001 995 41 02	-	-
101	004.180	1x	000 236 17 80	-	-

Mercedes-Benz

OM 471

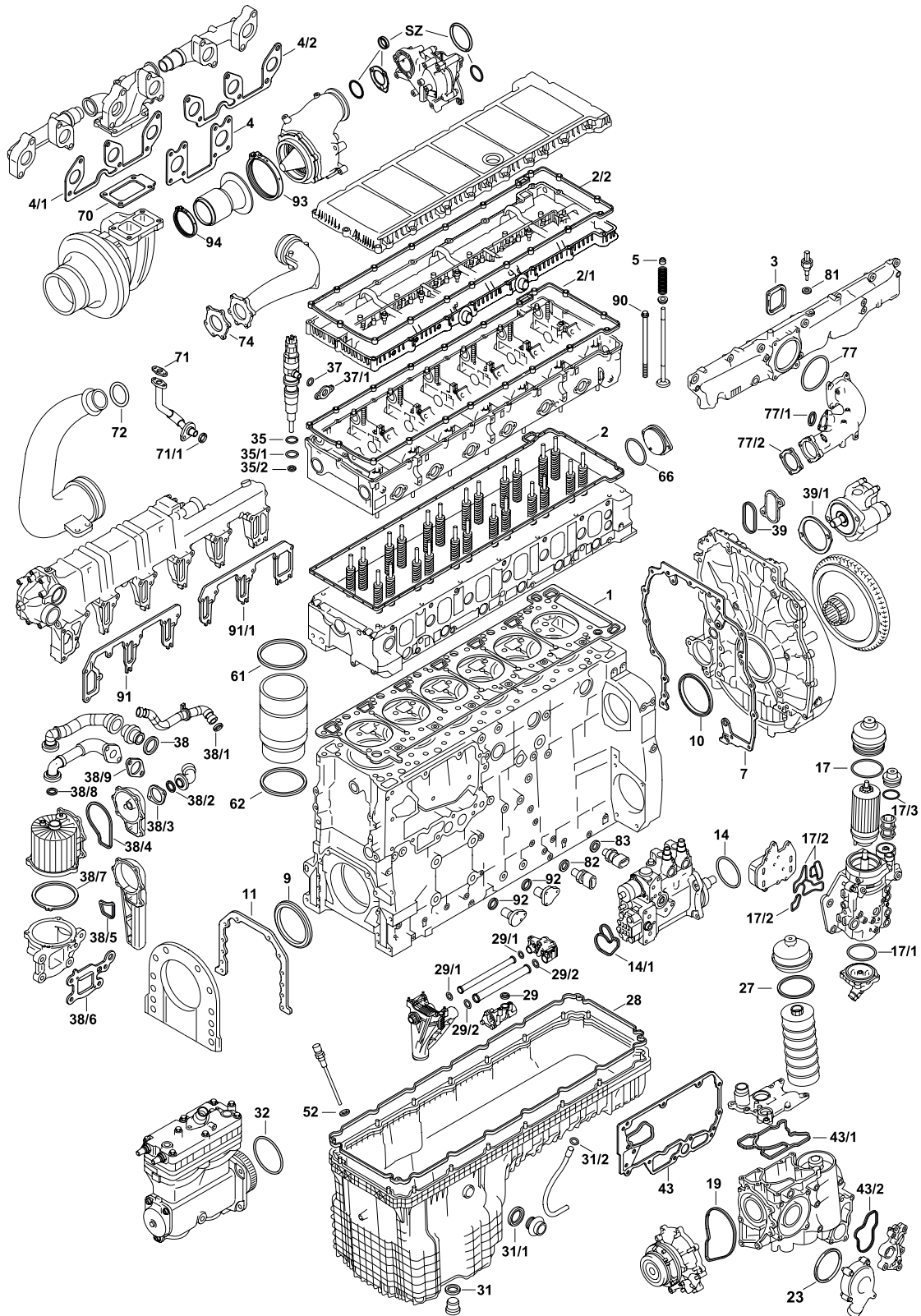





































471.900 | 902 | 906 | 909 | 919 | 922 | 926 | 927 | 928

471.932 | 933 | 934 | 935 | 937 | 938

471.940 | 941 | 944 | 946 | 951

Detroit Diesel DD13

MTU 6R 1300 C

			#			
	004.361	1x	-	-	-	  1x 539.940,  1x 603.480  077.200
	880.180	1x	-	-	-	 380.060  2x 539.940,  1x 603.480
	693.170	1x	-	-	-	 380.060  1x 539.940,  1x 571.272,  1x 603.480
	911.610	1x	-	-	-	 
	771.340	1x	471 010 35 05	-	-	 
	004.210	1x	471 016 00 69	M15x2x192	-	Kit
	340.330	1x	470 090 05 79	-	-	Inspection set diesel radiator
	972.680	1x	-	-	-	Gasket set waste gas turbine
	708.230	1x	472 010 60 62	-	-	Crankcase ventilation seal set
	840.870	1x	-	-	-	Gasket set oil cooler
	841.360	1x	460 070 09 87	-	-	Seal kit, injector nozzle
	972.620	1x	-	-	-	Kit
	654.270	1x	470 053 01 58	-	-	Kit
	854.330	6x	-	-	-	Cylinder liner seal kit
1	380.060	1x	471 016 07 20 471 016 03 20	Ø 133 mm $\frac{\pm}{\mu}$ 1,20 mm	-	-
1	601.800	1x	471 016 08 20 471 016 12 20	Ø 137 mm $\frac{\pm}{\mu}$ 1,20 mm	-	-
2	603.480	1x	471 016 04 80	-	-	-
2/1	539.940	1x	471 016 01 21	-	-	-
2/2	539.940	1x	471 016 01 21	-	-	-
2/2	571.272	1x	471 016 02 21	-	-	-
3	906.690	6x	472 098 00 80	-	-	-
4/1	906.780	1x	471 142 01 80	-	-	-
4/2	906.790	1x	471 142 02 80	-	-	-
5	906.760	24x	470 053 01 58	9x13,4/16,1x15,2 FPM	-	-
7	003.780	1x	471 015 01 80	-	-	-
9	905.480	1x	014 997 98 46	100x130x14 AW/SP RD FPM	-	-
10	003.770	1x	015 997 49 46	138x163x12 ASW LD PTFE/ACM	-	-
11	364.457	1x	472 011 02 80	-	-	-
14	002.920	1x	017 997 89 45	100x3,1 FPM RD	-	-

Mercedes-Benz

OM 471

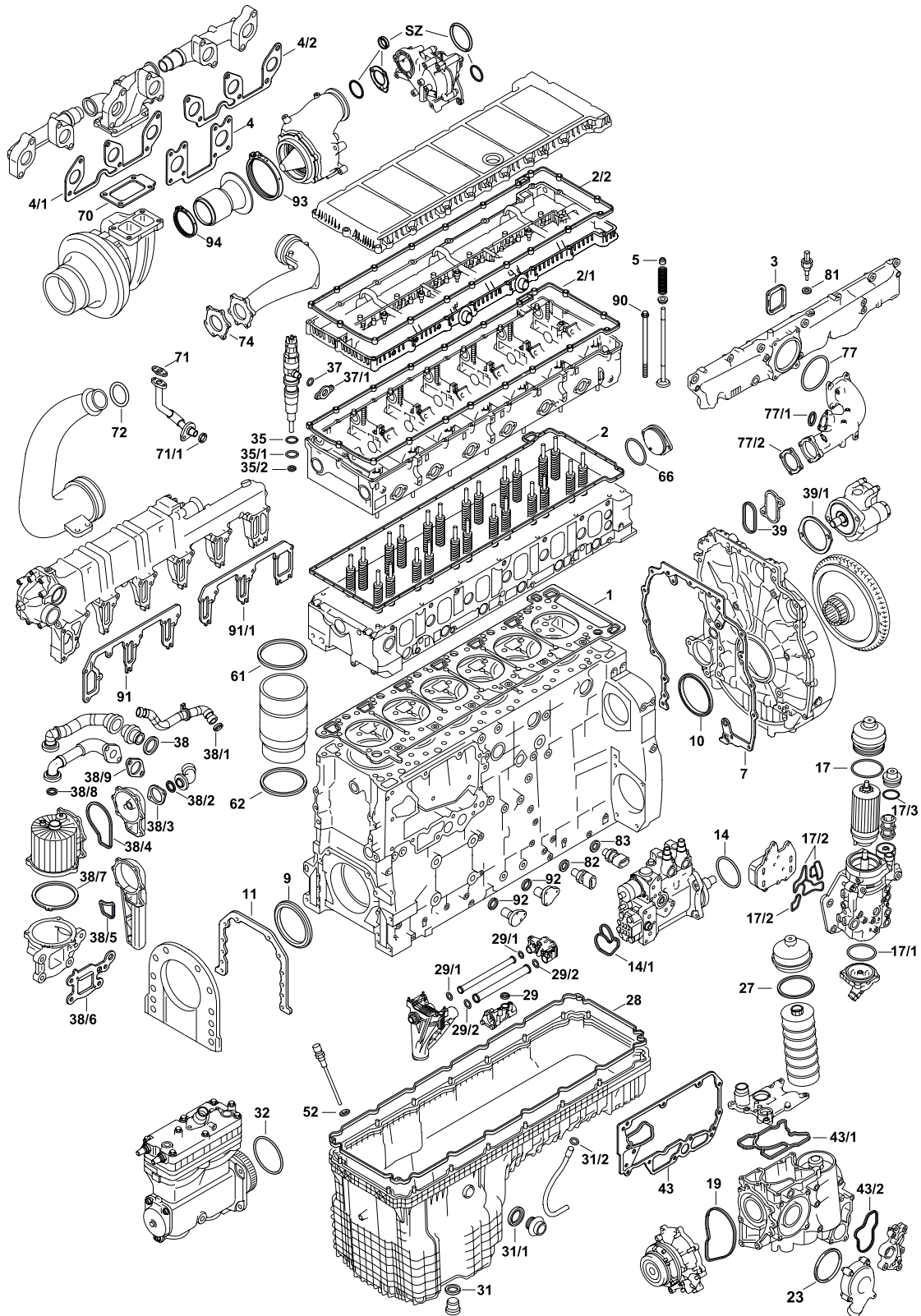



471.900 | 902 | 906 | 909 | 919 | 922 | 926 | 927 | 928

471.932 | 933 | 934 | 935 | 937 | 938

471.940 | 941 | 944 | 946 | 951

Detroit Diesel DD13

MTU 6R 1300 C



14/1	588.210	1x	000 091 08 60	-	-
17	003.010	1x	017 997 74 45	123,8x3,5 FPM RD	-
17/1	002.970	1x	017 997 94 45	114,2x2,58 FPM RD	-
17/1	653.980	1x	026 997 71 45	110,7x3,1 FMQ RD	-
17/1	339.530	1x	024 997 52 45	121,35x4,5 FPM RD	-
17/2	340.330	1x	470 090 05 79	-	-
17/3	003.020	1x	017 997 93 45	75,87x2,62 FPM RD	-
17/3	339.590	1x	021 997 33 45	62,75x3 FPM RD	-
19	004.010	1x	472 201 00 80	-	-
23	004.030	1x	472 203 00 80	-	-
27	744.970	1x	014 997 87 45	128x4 ACM RD	-
28	077.200	1x	471 014 07 22	AEM	-
28	567.350	1x	471 014 04 22	ACM	-
28	510.551	1x	471 014 00 22	AEM	-
29	003.190	1x	472 188 00 80	-	-
29/1	003.050	2x	472 187 09 80	38,3x48x6,2 FPM PR	-
29/2	003.040	2x	472 187 08 80	48,3x58x6,2 AEM PR	-
31	128.503	1x	000000 001085	22x27x1,5 CU A	-
31/1	478.740	1x	024 997 89 45	33,6x50x2 FE/ACM A	-
31/2	003.030	1x	024 997 88 45	22x29x1,5 FE/ACM A	-
32	651.250	1x	023 997 71 45	125,2x3,1 FPM RD	-
35	002.840	6x	017 997 88 45	29x3,5 FPM RD	-
35/1	002.820	6x	017 997 87 45	29,4x2,65 FPM RD	-
35/2	124.870	6x	906 017 02 60	7x15,1x1,5 CU PR	-
37	002.870	6x	017 997 86 45	13x2 FPM RD	-
37/1	002.880	6x	472 078 01 80	-	-
38	478.740	1x	024 997 89 45	33,6/38,3x50x2 AL/ACM	-
38/1	003.950	1x	457 997 06 45	26x2,5 NBR RD	-
38/2	003.970	1x	472 997 24 45 472 997 20 45	24,2x3 FPM RD	-
38/3	387.520	1x	472 018 01 80	-	-
38/4	003.960	1x	472 998 00 06	-	-
38/5	444.980	1x	472 015 07 80	-	-
38/6	719.750	1x	472 018 07 80	-	-
38/7	004.000	1x	472 015 08 80	-	-

Mercedes-Benz

OM 471

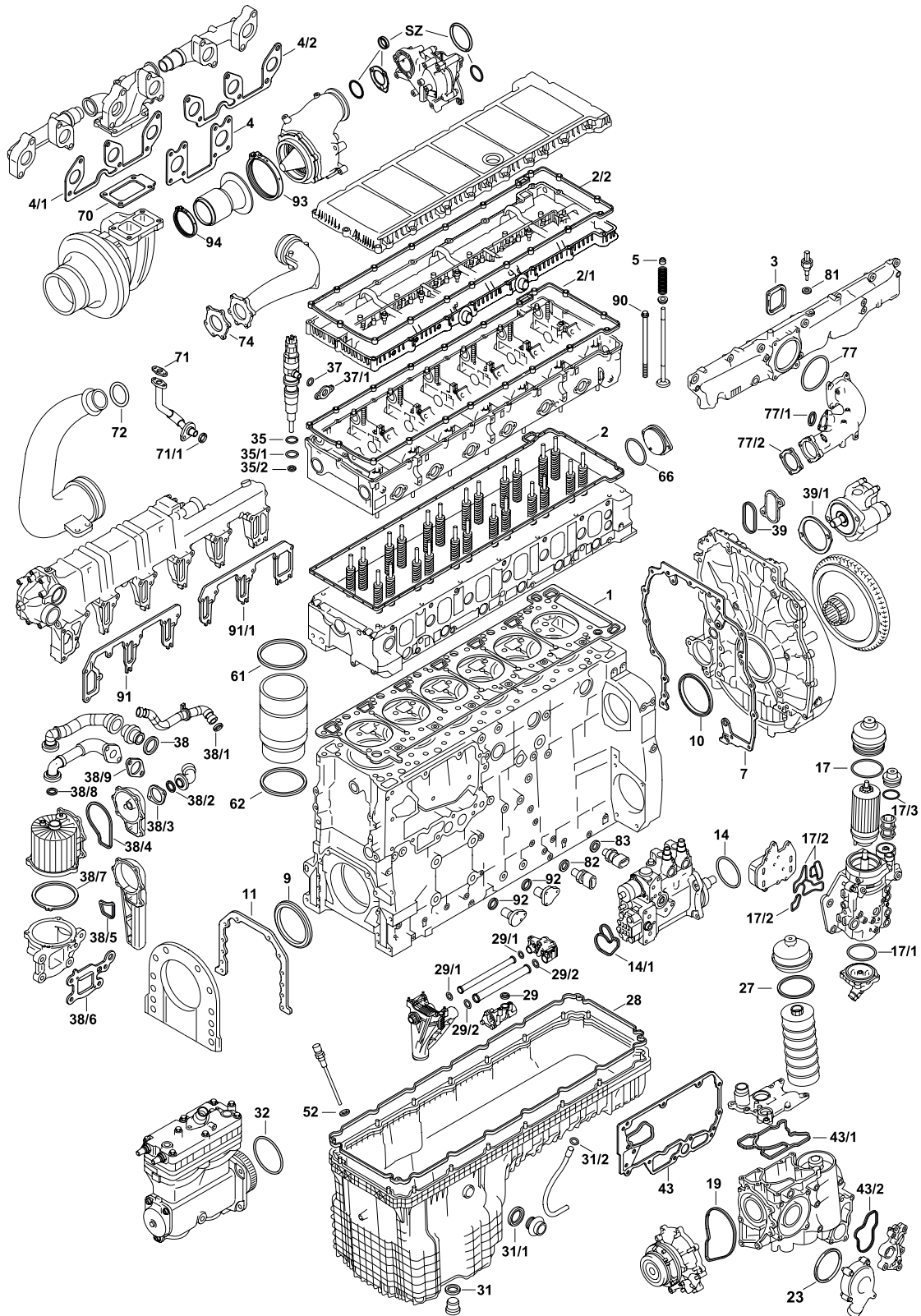



471.900 | 902 | 906 | 909 | 919 | 922 | 926 | 927 | 928

471.932 | 933 | 934 | 935 | 937 | 938

471.940 | 941 | 944 | 946 | 951

Detroit Diesel DD13

MTU 6R 1300 C



38/8	003.970	1x	472 997 24 45	24,2x3 FPM RD	-
38/9	387.520	1x	472 018 01 80	-	-
39	003.790	1x	472 015 02 80	-	-
39/1	004.180	1x	000 236 17 80	-	-
43	003.100	1x	472 184 19 80	-	-
43/1	003.200	1x	472 184 00 80	-	-
43/2	566.140	1x	472 188 15 80	-	-
43/2	658.410	1x	472 188 16 80	-	-
52	003.030	1x	024 997 88 45	22x29x1,5 AL/ACM	-
52		1x	024 997 86 45	-	-
61	003.881	6x	024 997 39 45	146,5x3,7 FPM PR	-
62	003.900	6x	018 997 48 45	131,5x135,8x2/4,5 FPM PR	-
66	906.670	1x	472 997 08 45	89,2x4 ACM RD	-
70	906.820	1x	471 096 03 80	-	-
71	527.090	1x	541 187 00 80	-	-
71/1	003.730	1x	018 997 31 45	21,7x5 ACM RD	-
72	491.970	1x	025 997 43 48	58x3,5 FPM RD	-
74	656.330	1x	471 142 06 80	-	-
77	906.740	1x	472 098 01 80	-	-
77	445.270	1x	472 098 08 80	112x10 FPM RD	-
77/1	906.700	1x	472 997 02 45	68x4 FPM RD	-
77/1	303.620	1x	472 098 06 80	-	-
77/2	906.710	1x	460 098 01 80	-	-
77/2	303.610	1x	472 098 04 80	-	-
81	804.980	1x	000000 001069	14x20x1,5 CU/ZNN A	-
82	804.980	1x	000000 001069	14x20x1,5 CU/ZNN A	-
83	804.990	1x	000000 001070	16x22x1,5 CU/ZNN A	-
90	004.210	1x	471 016 00 69	M15x2x192	Kit
91	906.860	1x	471 203 06 80	-	-
91/1	906.870	1x	471 203 07 80	-	-
92	816.957	4x	022 997 25 48	17x1,8 FPM RD	-
93	535.540	1x	000 995 82 02 002 995 15 02	-	-
94	535.550	1x	000 995 81 02 001 995 41 02	-	-

Mercedes-Benz



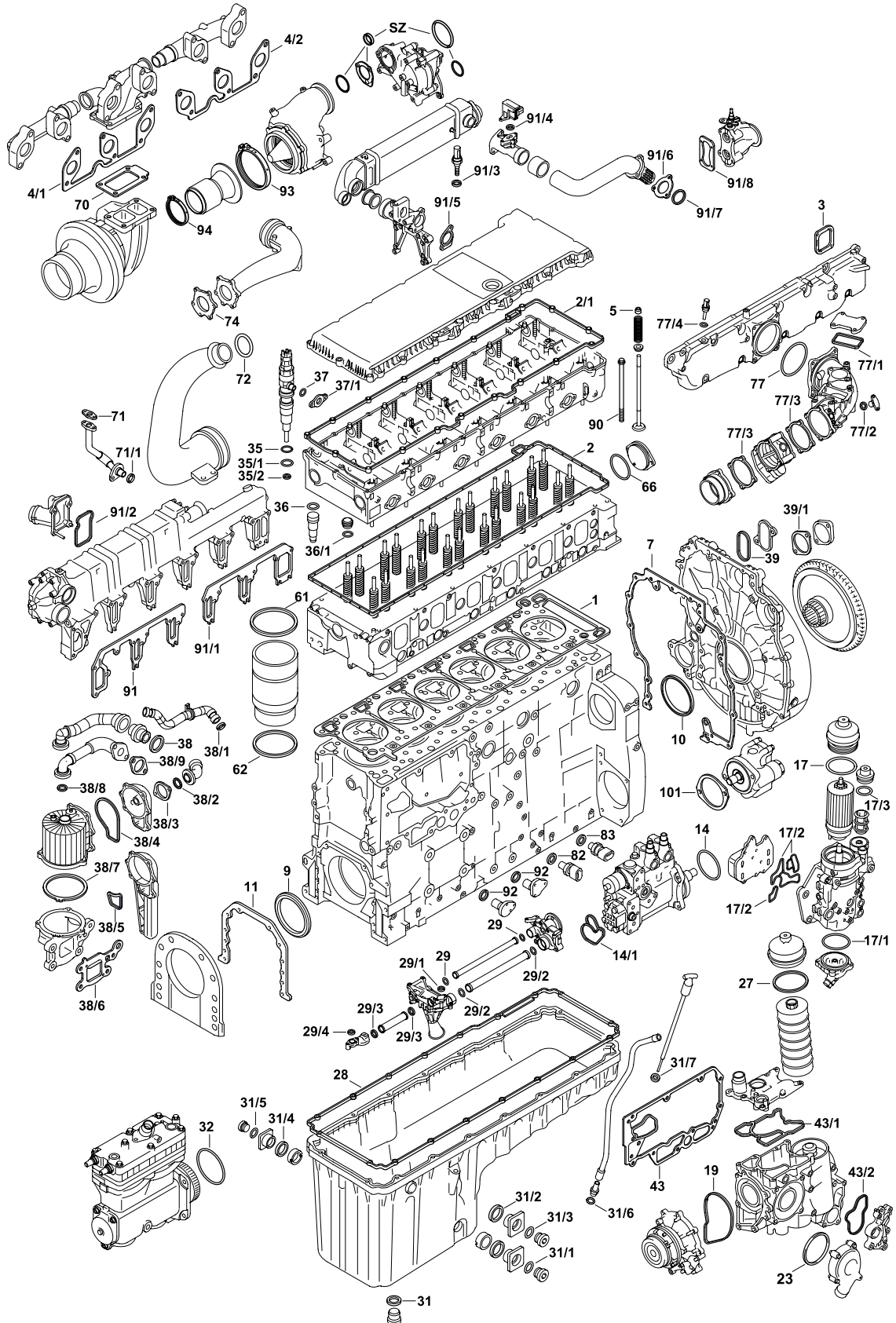

























OM 472





472.900 | 901 | 902 | 903 | 904 | 906 | 907 | 908 | 909 | 910 | 912

Detroit Diesel DD15

			#		
	934.240	1x	-	-	
	908.330	1x	-	-	
	767.630	1x	471 016 15 20	-	 396.472  237.690
	767.680	1x	472 016 19 20	-	 574.862  237.690
	767.760	1x	472 016 21 20	-	 896.235  237.690
	911.960	1x	-	-	
	968.450	1x	472 010 22 05	-	
	907.980	1x	-	M16x2x191	Kit
	580.580	1x	-	-	Kit
	340.330	1x	470 090 05 79	-	Inspection set diesel radiator
	972.680	1x	-	-	Gasket set waste gas turbine
	708.230	1x	472 010 60 62	-	Crankcase ventilation seal set
	841.360	1x	460 070 09 87	-	Seal kit, injector nozzle
	654.270	1x	470 053 01 58	-	Kit
	687.320	6x	-	-	Cylinder liner seal kit
1	396.472	1x	472 016 13 20	Ø 140 mm $\frac{\pm}{\mu}$ 1,20 mm	-
1	574.862	1x	472 016 14 20	Ø 140 mm $\frac{\pm}{\mu}$ 1,20 mm	-
1	896.235	1x	472 016 18 20	Ø 143,6 mm $\frac{\pm}{\mu}$ 1,20 mm	-
2	655.781	1x	472 016 06 80	-	-
2	-	1x	472 016 00 80 472 016 02 80	-	-
2	237.690	1x	472 016 07 80	-	-
2/1	571.300	1x	472 016 01 21	-	-
2/1	496.150	1x	472 016 01 80	-	-
3	906.690	6x	472 098 00 80	-	-
4/1	822.630	1x	472 142 18 80	-	-
4/2	822.640	1x	472 142 19 80	-	-
5	906.760	24x	470 053 01 58	9x13,4/16,1x15,2	-

Mercedes-Benz

OM 472

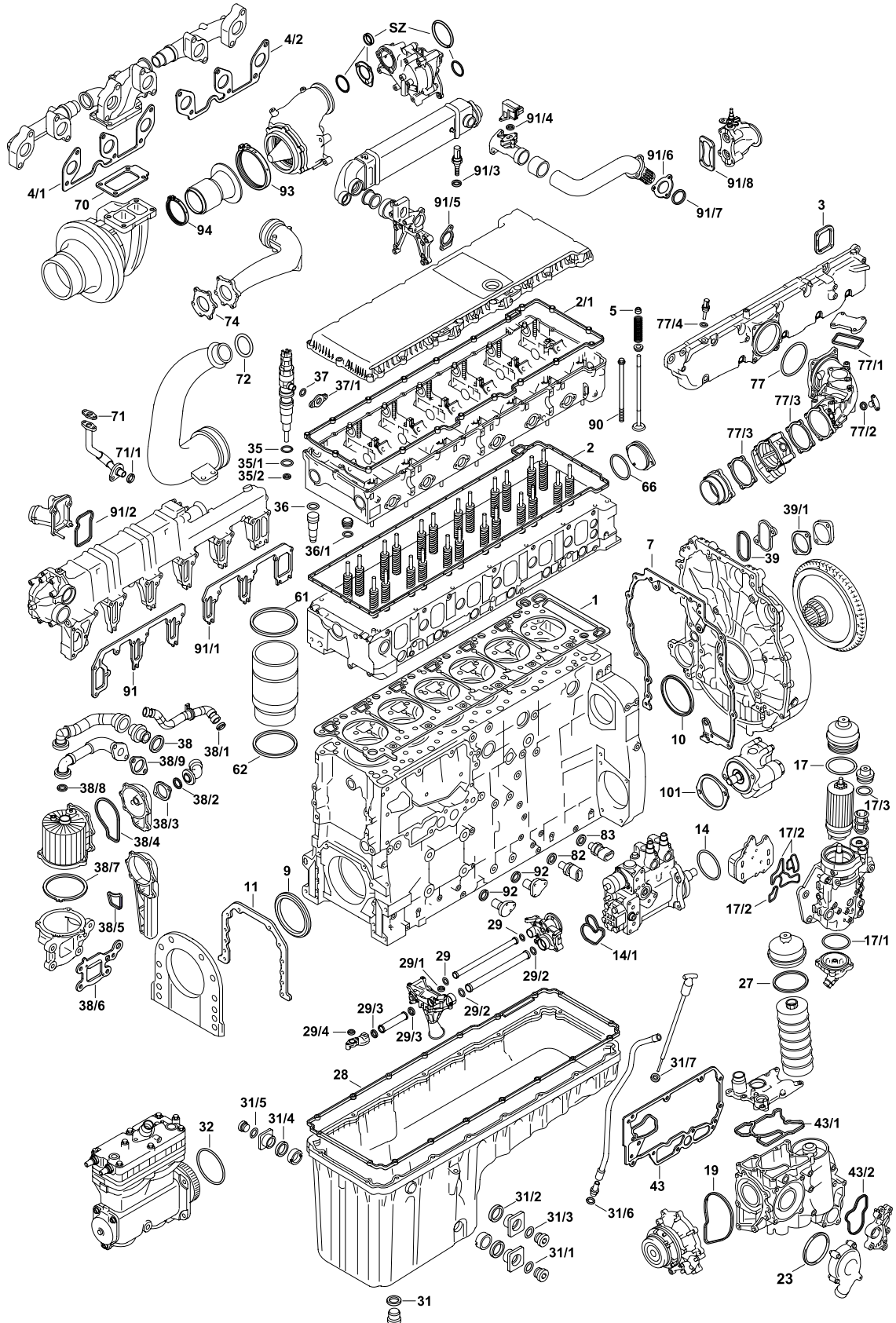



472.900 | 901 | 902 | 903 | 904 | 906 | 907 | 908 | 909 | 910 | 912
 Detroit Diesel DD15



7	949.510	1x	472 015 03 80	-	-
9	369.901	1x	016 997 06 46 015 997 97 46	100x130x11 ASW RD PTFE/ACM	-
10	003.770	1x	015 997 49 46	138x163x12 ASW LD PTFE/ACM	-
11	364.457	1x	472 011 02 80	-	-
14	002.920	1x	017 997 89 45	100x3,1 FPM RD	-
14/1	588.210	1x	000 091 08 60	-	-
17	003.010	1x	017 997 74 45	123,8x3,5 FPM RD	-
17	339.530	1x	022 997 31 45	121,35x4,5 FPM RD	-
17/1	002.970	1x	017 997 94 45	114,2x2,58 FPM RD	-
17/1	339.530	1x	024 997 52 45	121,35x4,5 FPM RD	-
17/1	653.980	1x	026 997 71 45	110,7x3,1 FMVQ RD	-
17/2	340.330	1x	470 090 05 79	-	-
17/3	339.590	1x	021 997 33 45	62,75x3 FPM RD	-
19	004.010	1x	472 201 00 80	-	-
23	004.030	1x	472 203 00 80	-	-
27	744.970	1x	014 997 87 45	128x4 ACM RD	-
28	392.071	1x	472 014 03 22	AEM	-
28	887.920	1x	473 014 01 22	ACM	-
28	927.190	1x	472 014 00 22	FE/ACM	-
29	003.050	2x	472 187 09 80	38,3x48x6,22 FPM PR	-
29/1	897.241	1x	472 188 14 80	-	-
29/1	566.180	1x	472 188 01 80	-	-
29/2	003.040	2x	472 187 08 80	48,3x58x6,2 AEM PR	-
29/3	003.050	2x	472 187 09 80	38,3x48x6,2 FPM PR	-
29/4	566.180	1x	472 188 01 80	-	-
31	250.007	1x	000000 001085	22x27x1,5 AL A	-
31/1	805.050	1x	N 000000 001074	30x36x2 CU/ZNN A	-
31/2		1x	472 018 03 80	-	-
31/3	135.100	1x	007603 027100	27x32x2 CU A	-
31/4		1x	472 018 03 80	-	-
31/5	135.100	1x	007603 027100	27x32x2 CU A	-
31/6	805.010	1x	000000 001071	18x24x1,5 CU/ZNN A	-

Mercedes-Benz

OM 472

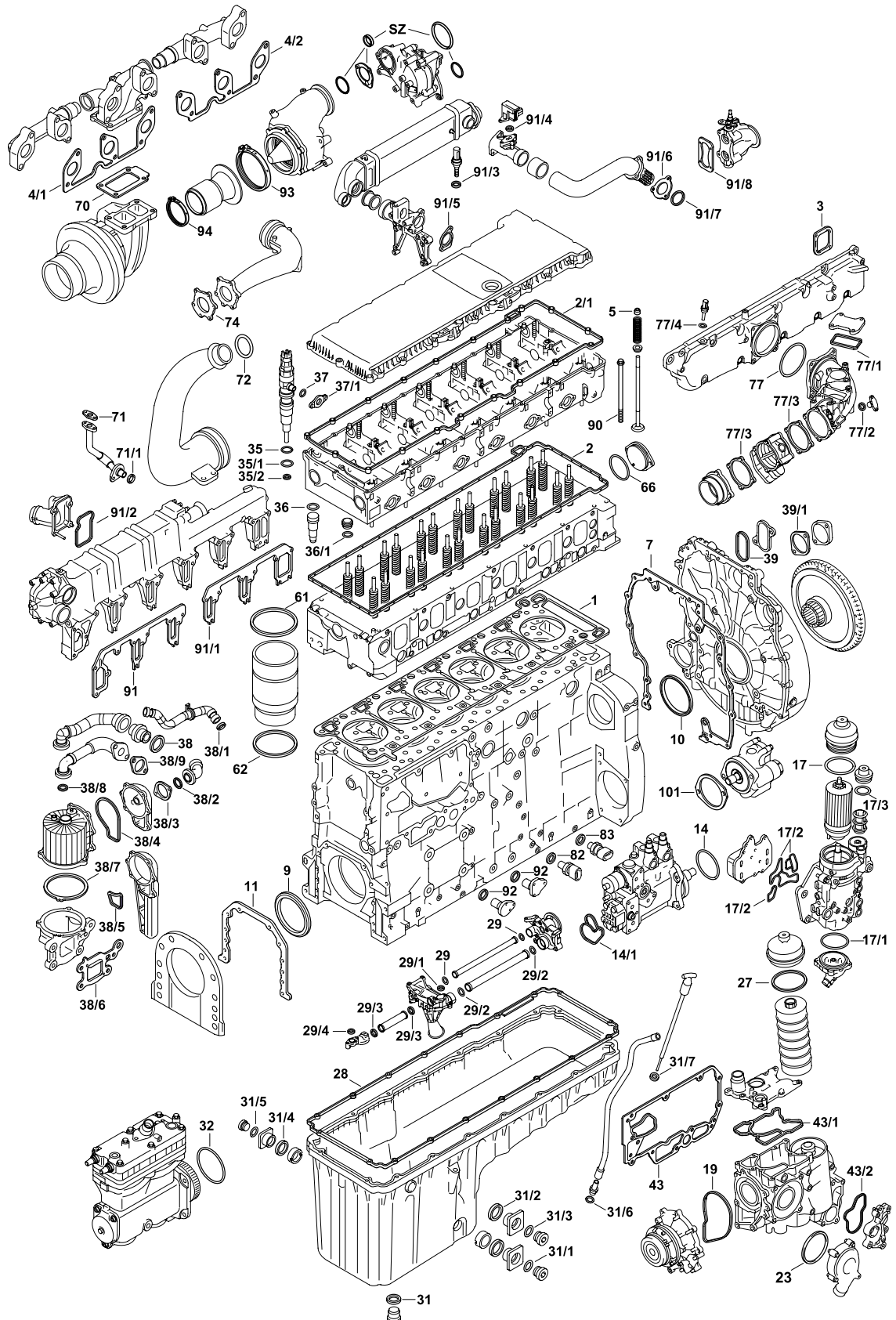



472.900 | 901 | 902 | 903 | 904 | 906 | 907 | 908 | 909 | 910 | 912

Detroit Diesel DD15



31/6	805.020	1x	000000 001072	20x26x1,5 CU/ZNN A	-
31/7	915.041	1x	014 997 41 48	10,5x2,7 NBR RD	-
32	651.250	1x	023 997 71 45	125,2x3,1 FPM RD	-
35	002.840	6x	017 997 88 45	29x3,5 FPM RD	-
35/1	002.820	6x	017 997 87 45	29,4x2,65 FPM RD	-
35/2	124.870	6x	906 017 02 60	7x15,1x1,5 CU A	-
36	339.480	6x	024 997 64 45	34x2,5 FPM RD	-
36/1	074.870	6x	541 997 03 45	25x3,7 FPM RD	-
37	002.870	6x	017 997 86 45	13x2 FPM RD	-
37/1	002.880	6x	472 078 01 80	-	-
38	003.950	1x	457 997 06 45	26x2,5 NBR RD	-
38/1	003.950	1x	457 997 06 45	26x2,5 NBR RD	-
38/2	003.970	1x	472 997 20 45 472 997 24 45	24,2x3 FPM RD	-
38/3	387.520	1x	472 018 01 80	-	-
38/4	003.960	1x	472 998 00 06	-	-
38/5	444.980	1x	472 015 07 80	-	-
38/6	719.750	1x	472 018 07 80	-	-
38/7	004.000	1x	472 015 06 80 472 015 08 80	-	-
38/8	003.970	1x	472 997 23 45 472 997 24 45	24,2x3 FPM RD	-
38/9	387.520	1x	472 018 01 80	-	-
39	003.790	1x	472 015 02 80	-	-
39/1	478.360	1x	472 015 01 80	84,1x88,3x2,7 ACM A	-
39/1	699.160	1x	000 236 18 80	-	-
43	003.100	1x	472 184 19 80	-	-
43/1	003.200	1x	472 184 00 80	-	-
43/2	003.690	1x	472 184 05 80	-	-
61	653.770	6x	024 997 48 45 022 997 52 45	155x162,4x3,9 FPM	-
62	653.760	6x	020 997 48 45 023 997 53 45	138,5x4,6 FPM	-
66	906.670	1x	472 997 08 45	89,2x4 ACM RD	-

Mercedes-Benz

OM 472

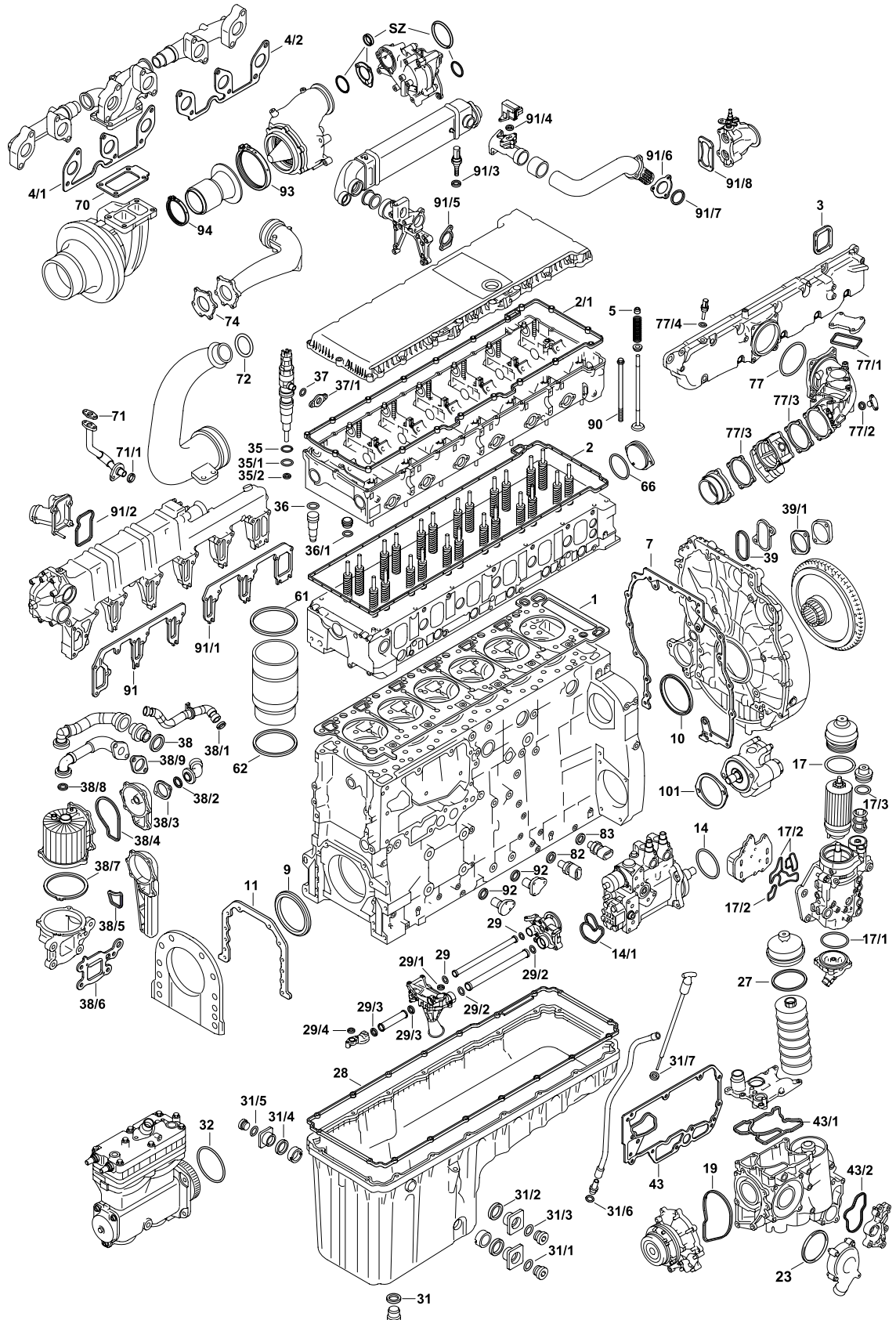



472.900 | 901 | 902 | 903 | 904 | 906 | 907 | 908 | 909 | 910 | 912

Detroit Diesel DD15

							
70	865.090	1x	473 096 02 80 472 096 03 80	-			-
71	527.090	1x	541 187 00 80	-			-
71/1	003.730	1x	018 997 31 45	21,7x5 ACM RD			-
72	491.970	1x	025 997 43 48	58x3,5 FPM RD			-
74	656.330	1x	471 142 06 80	-			-
77	906.740	1x	472 098 01 80	-			-
77	445.270	1x	472 098 08 80	112x10 FPM RD			-
77/1		1x	460 098 03 80	-			-
77/2	303.620	1x	472 098 06 80	-			-
77/3	906.710	2x	460 098 01 80	-			-
77/3	-	1x	460 098 04 80	-			-
77/4	804.980	1x	000000 001069	14x20x1,5 CU/ZNN A			-
82	804.980	1x	000000 001069	14x20x1,5 CU/ZNN A			-
83	804.990	1x	000000 001070	16x22x1,5 CU/ZNN A			-
90	907.980	38x	472 016 01 69	M16x2x191			Kit
91	873.400	1x	472 203 08 80	-			-
91/1	873.410	1x	472 203 09 80	-			-
91/2		1x	472 203 01 80	-			-
91/3	804.980	1x	000000 001069	14x20x1,5 CU/ZNN A			-
91/4	-	1x	470 153 00 80	-			-
91/5	-	1x	472 142 08 80	-			-
91/6	559.220	1x	472 096 01 80	-			-
91/7	906.700	1x	472 997 02 45 472 997 09 45	68x4 FPM RD			-
91/8	593.880	1x	472 142 20 80	-			-
92	816.957	4x	022 997 25 48	17x1,8 FPM RD			-
93	535.540	1x	000 995 82 02 002 995 15 02	-			-
94	535.550	1x	000 995 81 02 001 995 41 02	-			-

Mercedes-Benz

OM 473

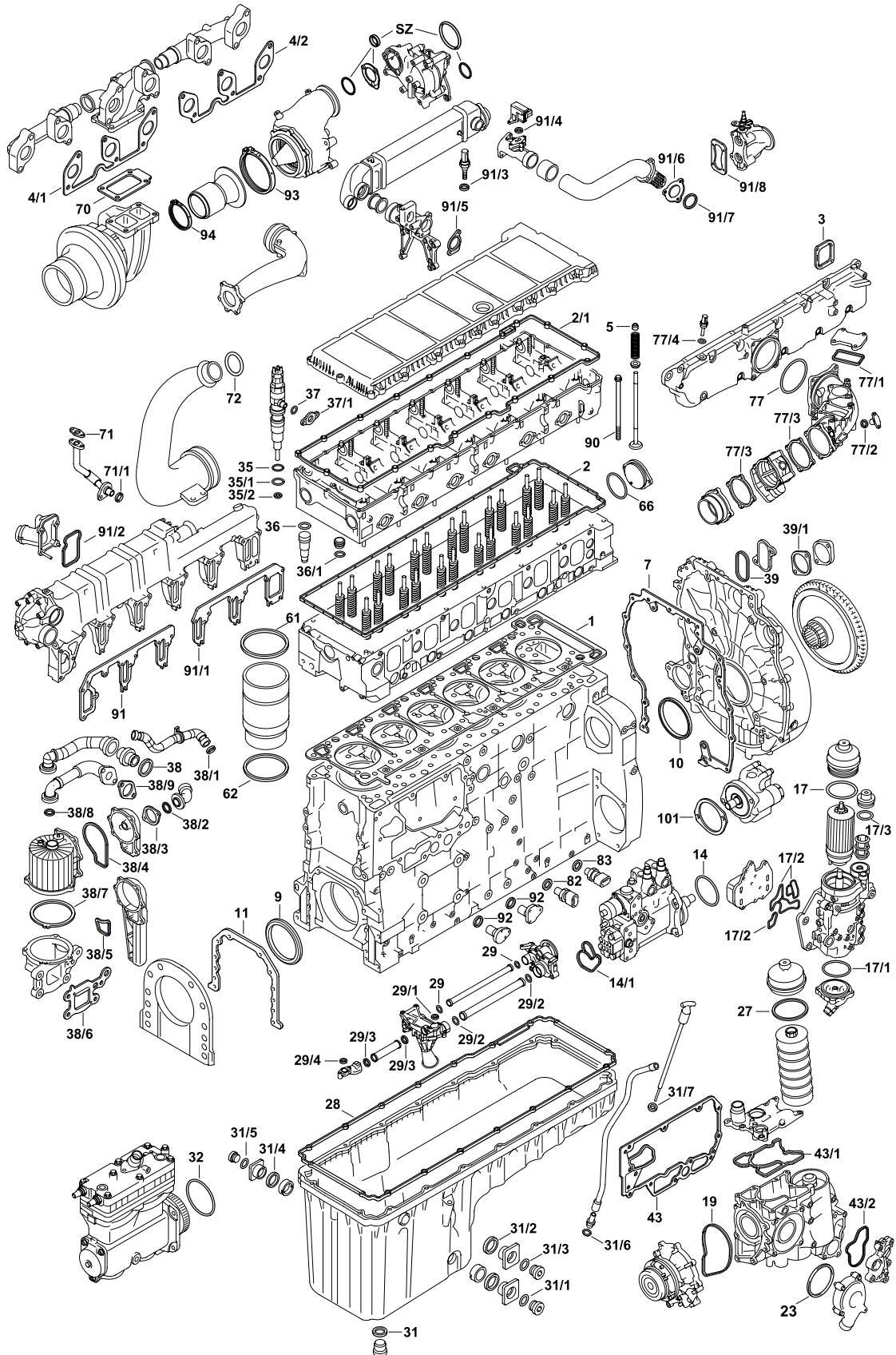

























473.900 | 901 | 902 | 903 | 905 | 907 | 908 | 909 | 910 | 914 | 915 | 917 | 918 | 919

Detroit Diesel DD16

MTU 6R 1500

			#	  	
	656.390	1x	-	-	
	945.300	1x	-	-	
	945.300	1x	-	-	 
	907.980	1x	-	M16x2x191	Kit
	631.090	1x	-	-	Kit
	340.330	1x	470 090 05 79	-	Inspection set diesel radiator
	972.680	1x	-	-	Gasket set waste gas turbine
	841.330	1x	-	-	Gasket set oil cooler
	708.230	1x	472 010 60 62	-	Crankcase ventilation seal set
	841.360	1x	460 070 09 87	-	Seal kit, injector nozzle
	687.320	6x	-	-	Cylinder liner seal kit
	654.270	1x	470 053 01 58	-	Kit
1	574.862	1x	472 016 14 20	∅ 140 mm $\frac{\pm}{\text{mm}}$ 1,20 mm	-
1	896.235	1x	472 016 18 20	∅ 143,6 mm $\frac{\pm}{\text{mm}}$ 1,20 mm	-
2	655.781	1x	472 016 06 80	-	-
2/1	571.300	1x	472 016 01 21	-	-
3	906.690	6x	472 098 00 80	-	-
4/1	822.630	1x	472 142 18 80	-	-
4/2	822.640	1x	472 142 19 80	-	-
5	906.760	24x	470 053 01 58	9x13,4/16,1x15,2 FPM	-
7	949.510	1x	472 015 03 80	-	-
9	905.480	1x	014 997 98 46	100x130x14 AW/SP RD FPM	-
10	003.770	1x	015 997 49 46	138x163x12 ASW LD PTFE/ACM	-
11	364.457	1x	472 011 02 80	-	-
14	002.920	1x	017 997 89 45	100x3,1 FPM RD	-
14/1	588.210	1x	000 091 08 60	-	-
17	003.010	1x	017 997 74 45	123,8x3,5 FPM RD	-
17	339.530	1x	024 997 52 45	121,35x4,5 FPM RD	-
17/1	002.970	1x	017 997 94 45	114,2x2,58 FPM RD	-
17/1	339.530	1x	024 997 52 45	121,35x4,5 FPM RD	-
17/1	653.980	1x	026 997 71 45	110,7x3,1 FMVQ RD	-

Mercedes-Benz

OM 473

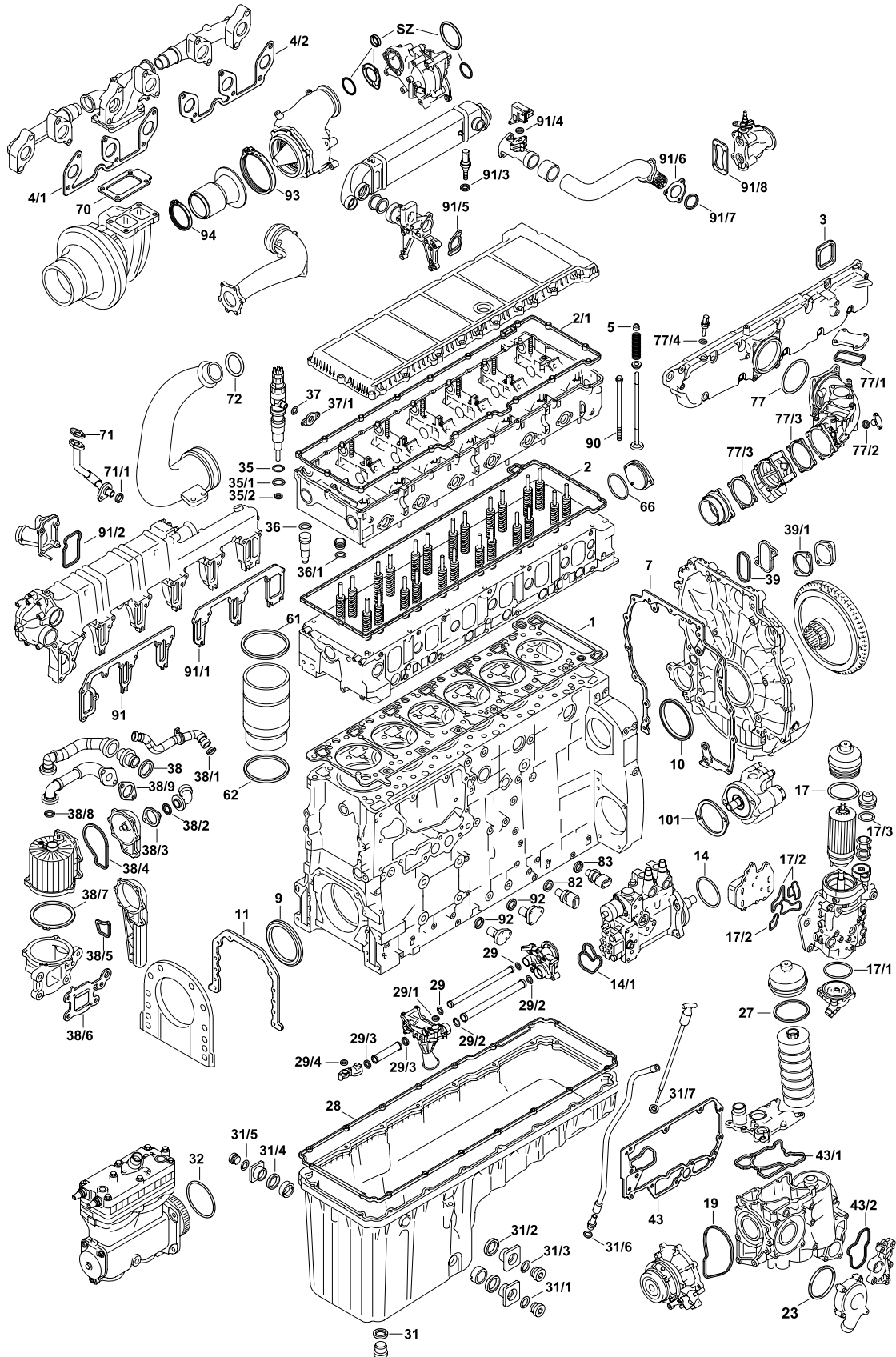



473.900 | 901 | 902 | 903 | 905 | 907 | 908 | 909 | 910 | 914 | 915 | 917 | 918 | 919

Detroit Diesel DD16

MTU 6R 1500



17/2	340.330	1x	470 090 05 79	-	-
17/3	339.590	1x	021 997 33 45	62,75x3 FPM RD	-
19	004.010	1x	472 201 00 80	-	-
23	004.030	1x	472 203 00 80	-	-
27	744.970	1x	014 997 87 45	128x4 ACM RD	-
28	392.071	1x	472 014 03 22	-	-
28	887.920	1x	473 014 01 22	-	-
28	927.190	1x	472 014 00 22	-	-
29	003.050	2x	472 187 09 80	38,3x48x6,2 FPM PR	-
29/1	566.180	1x	472 188 01 80	-	-
29/1	897.241	1x	472 188 14 80	-	-
29/2	003.040	2x	472 187 08 80	48,3x58x6,2 AEM PR	-
29/3	003.050	2x	472 187 09 80	38,3x48x6,2 FPM PR	-
29/4	566.180	1x	472 188 01 80	-	-
31	-	1x	472 997 15 45	-	-
31/1	805.050	1x	N 000000 001074	30x36x2 CU/ZNN A	-
31/2		1x	472 018 03 80	-	-
31/3	135.100	1x	007603 027100	27x32x2 CU A	-
31/4		1x	472 018 03 80	-	-
31/5	135.100	1x	007603 027100	27x32x2 CU A	-
31/6	805.010	1x	000000 001071	18x24x1,5 CU/ZNN A	-
31/6	805.020	1x	000000 001072	20x26x1,5 CU/ZNN A	-
31/7	915.041	1x	014 997 41 48	10,5x2,7 NBR RD	-
32	004.160	1x	017 997 28 45	125,2x3 ACM RD	-
32	651.250	1x	023 997 71 45	125,2x3,1 FPM RD	-
35	002.840	6x	017 997 88 45	29x3,5 FPM RD	-
35/1	002.820	6x	017 997 87 45	29,4x2,65 FPM RD	-
35/2	124.870	6x	906 017 02 60	7x15,1x1,5 CU A	-
36	339.480	6x	024 997 64 45	34x2,5 FPM RD	-
36/1	074.870	6x	541 997 03 45	25x3,7 FPM RD	-
37	002.870	6x	017 997 86 45	13x2 FPM RD	-
37/1	002.880	6x	472 078 01 80	-	-

Mercedes-Benz

OM 473

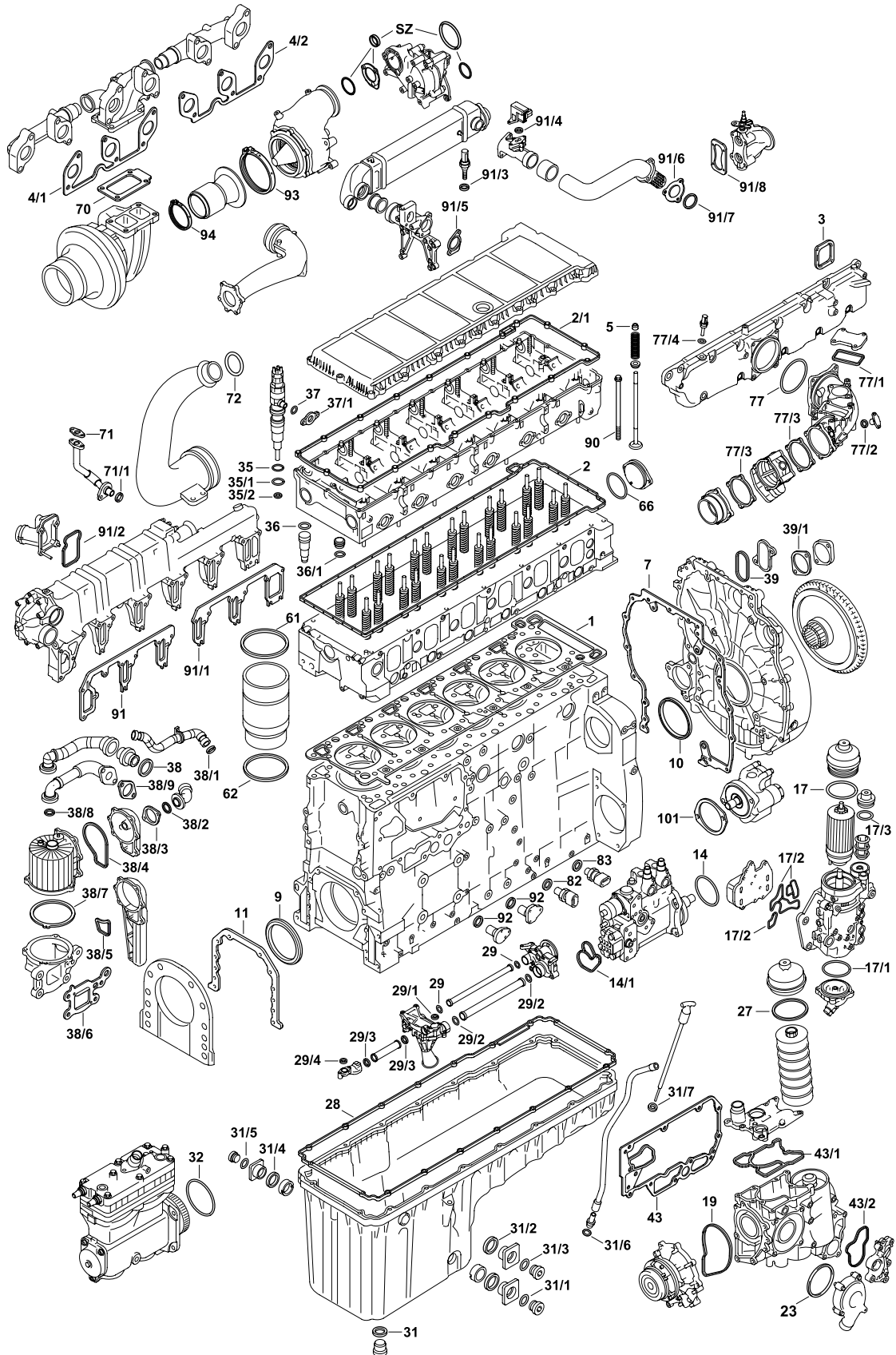



473.900 | 901 | 902 | 903 | 905 | 907 | 908 | 909 | 910 | 914 | 915 | 917 | 918 | 919

Detroit Diesel DD16

MTU 6R 1500



38	478.740	1x	024 997 89 45	33,6x38,3x50x2 AL/ACM	-
38/1	003.950	1x	457 997 06 45	26x2,5 NBR RD	-
38/2	003.970	1x	472 997 24 45	24,2x3 FPM RD	-
38/3	387.520	1x	472 018 01 80	-	-
38/4	003.960	1x	472 998 00 06	-	-
38/5	444.980	1x	472 015 07 80	-	-
38/6	719.750	1x	472 018 07 80	-	-
38/7	004.000	1x	472 015 06 80 472 015 08 80	-	-
38/8	003.970	1x	472 997 23 45 472 997 24 45	24,2x3 FPM RD	-
38/9	387.520	1x	472 018 01 80	-	-
39	003.790	1x	472 015 02 80	-	-
39/1	478.360	1x	472 015 01 80	84,1x88,3x2,7 ACM A	-
39/1	699.160	1x	000 236 18 80	-	-
43	003.100	1x	472 184 19 80	-	-
43/1	003.200	1x	472 184 00 80	-	-
43/2	003.690	1x	472 184 05 80	-	-
43/2	566.140	1x	472 188 15 80	-	-
61	653.770	6x	024 997 48 45 022 997 52 45	155x162,4x3,9 FPM	-
62	653.760	6x	020 997 48 45 023 997 53 45	138,5x4,6 FPM	-
66	906.670	1x	472 997 08 45	89,2x4 ACM RD	-
70	865.090	1x	473 096 02 80	-	473.901/902/908
70	865.060	1x	473 096 04 80 473 096 03 80	-	-
71	527.090	1x	541 187 00 80	-	-
71/1	003.730	1x	018 997 31 45	21,7x5 ACM RD	-
72	456.070	1x	012 997 42 45	55x3 FPM RD	-
77	906.740	1x	472 098 01 80	-	-
77	445.270	1x	472 098 08 80	112x10 FPM RD	-
77/1		1x	460 098 03 80	-	-
77/2	894.460	1x	140 832 06 99	14x2,5 EPDM RD	-
77/3	906.710	2x	460 098 01 80	-	-

Mercedes-Benz

OM 473

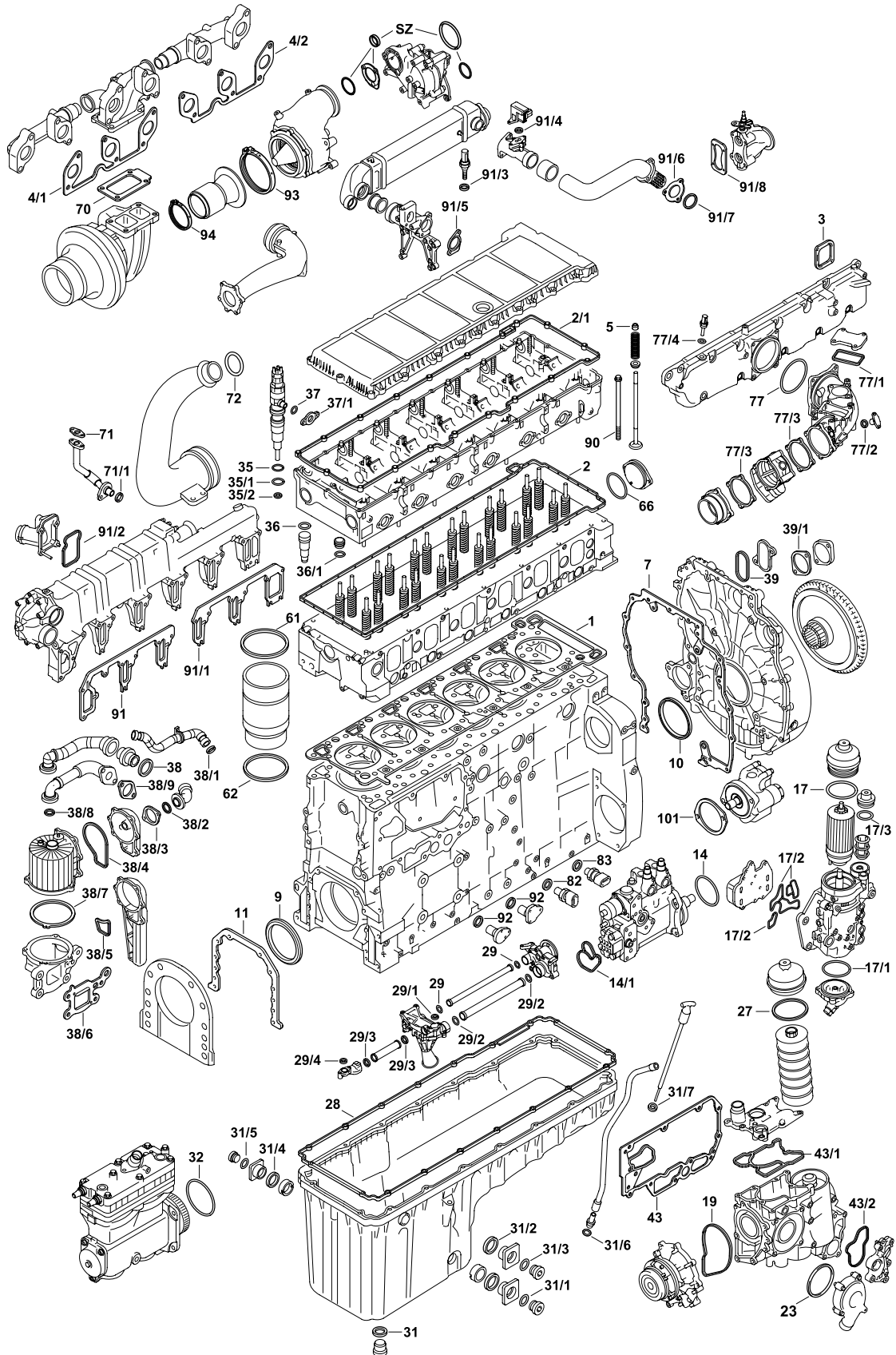



473.900 | 901 | 902 | 903 | 905 | 907 | 908 | 909 | 910 | 914 | 915 | 917 | 918 | 919

Detroit Diesel DD16

MTU 6R 1500



77/3	-	1x	460 098 04 80	-	-
77/4	804.980	1x	000000 001069	14x20x1,5 CU/ZNN A	-
82	804.980	1x	000000 001069	14x20x1,5 CU/ZNN A	-
83	804.990	1x	000000 001070	16x22x1,5 CU/ZNN A	-
90	907.980	1x	472 016 01 69	M16x2x191	Kit
91	873.400	1x	472 203 08 80	-	-
91/1	873.410	1x	472 203 09 80	-	-
91/2		1x	472 203 01 80	-	-
91/2	004.070	1x	473 203 00 80	-	-
91/3	804.980	1x	000000 001069	14x20x1,5 CU/ZNN A	-
91/4	-	1x	470 153 00 80	-	-
91/5	-	1x	472 142 08 80	-	-
91/6	559.220	1x	472 096 01 80	-	-
91/7	906.700	1x	472 997 02 45 472 997 09 45	68x4 FPM RD	-
91/8	593.880	1x	472 142 20 80	-	-
92	816.957	4x	022 997 25 48	17x1,8 FPM RD	-
93	535.540	1x	000 995 82 02 002 995 15 02	-	-
94	535.550	1x	000 995 81 02 001 995 41 02	-	-



1. Exclusion of liability

All information in this catalog has been carefully prepared by us. We accept no liability for the accuracy and completeness of data contained in this catalog. Any claim of damages against us arising from the use of the data contained in the catalog, or the use of any erroneous or incomplete data, is excluded. Subject to technical developments and changes. Before installing any replacement parts named in this catalog, it must be checked whether the parts are suitable for the intended purpose. Our technical service department is available for this at any time. In case of doubt, seek clarification. We expressly give notice that all replacement parts must be installed by trained, qualified personnel.

2. Notification of copyright and trademark law

The copyright for texts, graphics, and image documents created by us remains ours. Any imitation, reproduction, or use of such objects in other printed or electronic publications requires our written permission and citation of the source.

3. Terms and conditions

We give express notice that delivery is made exclusively under our general terms and conditions. The current edition of our general sales and delivery conditions is available on our Internet site, at: www.elring.de/agb_en

We will be happy to send them to you upon request.

4. Miscellaneous

Names, descriptions, and numbers of vehicles and manufacturers and the like are intended solely for internal comparison purposes. The same applies to original spare part numbers from the vehicle and engine manufacturers. They are not an indication of origin and must not be used with vehicle owners.

Previous editions become obsolete with the publication of this catalog.

1. Haftungsausschluss

Sämtliche Angaben in diesem Katalog wurden von uns sorgfältig und fundiert bearbeitet. Wir übernehmen für die Richtigkeit und Vollständigkeit der im Katalog enthaltenen Angaben keine Gewähr. Sämtliche Ersatzansprüche gegen uns, die durch die Nutzung der im Katalog enthaltenen Angaben bzw. durch die Nutzung eventuell fehlerhafter oder unvollständiger Angaben verursacht wurden, sind ausgeschlossen. Laufende technische Entwicklungen oder Änderungen bleiben vorbehalten. Vor dem Einbau der in diesem Katalog genannten Ersatzteile ist zu prüfen, ob die Teile für den geplanten Verwendungszweck geeignet sind. Hierfür steht unser technischer Kundendienst jederzeit zur Verfügung. In allen Zweifelsfällen sollte Rücksprache erfolgen. Wir weisen ausdrücklich darauf hin, dass alle Ersatzteile von geschultem Fachpersonal eingebaut werden müssen.

2. Hinweise zum Urheber- und Kennzeichnungsrecht

Das Urheberrecht für die von uns erstellten Texte, Grafiken und Bilddokumente bleibt allein bei uns. Eine Nachahmung, Vervielfältigung oder Verwendung solcher Objekte in anderen gedruckten oder elektronischen Publikationen ist nur mit unserer schriftlichen Genehmigung und mit Quellenangabe gestattet.

3. AGB

Wir weisen ausdrücklich darauf hin, dass Lieferungen ausschließlich zu unseren Allgemeinen Verkaufs- und Lieferbedingungen erfolgen. Die aktuelle Fassung unserer Allgemeinen Verkaufs- und Lieferbedingungen ist auf unserer Internetseite unter: www.elring.de/agb_de veröffentlicht.

Auf Wunsch senden wir Ihnen diese auch gerne zu.

4. Sonstiges

Namen, Beschreibungen, Nummern von Fahrzeugen und Herstellern und Ähnliches sind ausschließlich zu internen Vergleichszwecken bestimmt. Gleiches gilt für Original-Ersatzteilnummern der Fahrzeug- und Motorenhersteller. Sie sind keine Herkunftsbezeichnung und dürfen Fahrzeugbesitzern gegenüber nicht verwendet werden.

Mit Erscheinen dieses Katalogs verlieren frühere Ausgaben ihre Gültigkeit.

1. Limitation de responsabilité

Nous avons apporté le plus grand soin à la rédaction et à la vérification des informations figurant dans ce catalogue. Toutefois, nous ne pouvons garantir de manière absolue l'exactitude et l'intégrité des informations fournies. En conséquence, nous ne pouvons en aucun cas être tenus responsables de tout préjudice résultant de l'utilisation des informations de ce catalogue ou de l'utilisation d'une information erronée ou incomplète. Nous nous réservons le droit de modifier ou d'adapter nos produits aux évolutions technologiques. Avant de procéder au montage des pièces de rechange citées dans ce catalogue, vérifiez si celles-ci sont adaptées à l'utilisation prévue. Notre service clientèle est à votre disposition pour tout renseignement à ce sujet. En cas de doute, il est fortement recommandé de lui demander conseil. Nous vous avisons explicitement que tout remplacement de pièce doit impérativement être effectué par des techniciens spécialisés.

2. Propriété intellectuelle et propriété industrielle

Tous les textes, graphismes et éléments visuels créés par nous nous sont réservés au titre de la propriété industrielle. A ce titre, toute reproduction, adaptation ou utilisation, totale ou partielle, sur un support papier ou informatique, ne pourra être faite sans notre autorisation écrite et sans citation explicite de la source.

3. CGV

Nous vous avisons explicitement que les présentes conditions générales de vente sont les seules applicables aux produits et services fournis par notre société. La version actuellement en vigueur de nos conditions générales de vente est disponible sur notre site Internet : www.elring.de/agb_en

Celles-ci peuvent vous être envoyées par courrier sur simple demande.

4. Dispositions diverses

Les noms, descriptifs, numéros de véhicules et de constructeurs et autres références sont mentionnés à des fins exclusives de comparaison en interne. Ceci concerne également les numéros des pièces de rechange d'origine des constructeurs automobiles et motoristes. Ces numéros ne constituent pas une indication d'origine et ne doivent pas être utilisés à l'endroit des propriétaires des véhicules.

Ce catalogue remplace et annule les éditions précédentes.



1. Exención de responsabilidad

Todos los datos de este catálogo han sido elaborados de manera cuidadosa y fundamentada. La empresa no se responsabiliza por la corrección ni por la exhaustividad de los datos incluidos en el catálogo. No se admiten reclamaciones de indemnización derivadas del uso de datos incluidos en este catálogo o provocadas por la presencia de datos ocasionalmente erróneos o incompletos. La empresa se reserva el derecho de introducir modificaciones y mejoras técnicas. Antes de montar las piezas de recambio mencionadas en este catálogo, es necesario verificar si las piezas son adecuadas para el uso previsto. Nuestro servicio técnico de atención al cliente está siempre a su disposición. En caso de duda, debe realizarse la consulta correspondiente. Se hace constar expresamente que todas las piezas de recambio deben ser montadas por personal técnico cualificado.

2. Notas de copyright y derechos de autor

Los derechos de autor correspondientes a textos, gráficos e imágenes elaborados por la empresa son propiedad exclusiva de la empresa. La copia, reproducción o utilización de dichos elementos en otras publicaciones impresas o electrónicas sólo están permitidas si existe una autorización por escrito de la empresa y se menciona la fuente.

3. Condiciones Generales

Se hace constar expresamente que las entregas sólo tienen lugar en el marco de nuestras Condiciones Generales de Venta y Suministro. La versión vigente de las Condiciones Generales de Venta y Suministro está publicada en nuestro sitio de Internet en la dirección: www.elring.de/agb_en

Si lo desea, podemos enviarle un ejemplar.

4. Otros

Los nombres, las descripciones, los números de vehículos y fabricantes y similares se utilizan exclusivamente con fines comparativos a nivel interno. Lo mismo es válido para los números de piezas de recambio originales de los fabricantes de vehículos y motores. No son denominaciones de origen y no deben utilizarse ante los propietarios de los vehículos.

Con la aparición de este catálogo pierden su validez las versiones anteriores.

1. Esclusione di responsabilità

Tutti i dati riportati nel presente catalogo sono stati da noi accuratamente elaborati su basi fondate. Non forniamo alcuna garanzia riguardo all'esattezza e alla completezza dei dati riportati nel catalogo. È escluso qualsiasi diritto di rimborso nei nostri confronti, qualora sia dovuto all'applicazione dei dati contenuti nel catalogo, ovvero all'applicazione di eventuali dati errati o incompleti. Ci riserviamo di apportare eventuali modifiche o di adeguarci agli sviluppi tecnologici in corso. Prima di montare i pezzi di ricambio riportati nel presente catalogo, occorre verificare se i pezzi sono adeguati agli scopi d'utilizzo previsti. Il nostro servizio clienti per problematiche tecniche è a vostra completa disposizione. In caso di dubbio, rivolgersi sempre al servizio competente. Facciamo espressamente notare che tutti i pezzi di ricambio devono essere montati da personale tecnico qualificato.

2. Avvertenze sui diritti d'autore e sul diritto ad apporre il contrassegno

I diritti d'autore per i testi, i grafici e i documenti fotografici da noi prodotti sono di nostro esclusivo appannaggio. L'imitazione, la riproduzione o l'utilizzo di tali oggetti in altre pubblicazioni stampate o elettroniche sono consentite esclusivamente previa nostra autorizzazione scritta e con citazione della fonte.

3. CG

Facciamo espressamente notare che le spedizioni avvengono esclusivamente alle nostre condizioni generali di fornitura e di vendita. La versione attuale delle nostre condizioni generali di fornitura e di vendita può essere consultata sulla nostra pagina web: www.elring.de/agb_en

Su richiesta, saremo lieti di inviarvene una copia.

4. Varie

Nomi, descrizioni, numeri di veicoli e produttori, nonché altri dati analoghi sono destinati ai soli scopi comparativi interni. Lo stesso vale per i numeri dei pezzi di ricambio originali del produttore dei motori e del veicolo. Essi non presentano alcuna indicazione di origine e non devono essere utilizzati da parte del proprietario del veicolo.

Con la pubblicazione del presente catalogo, le edizioni precedenti non sono più valide.

1. Исключение ответственности

Все указания и сведения в данном каталоге отбирались и обрабатывались тщательным и обоснованным образом. Мы не предоставляем какой-либо гарантии за правильность и полноту сведений, приведенных в каталоге. Направление каких-либо требований на возмещение убытков, связанных с использованием сведений, приведенных в каталоге, или связанных с использованием возможных ошибочных или неполных указаний полностью исключается. Мы оставляем за собой право вносить изменения в связи с текущим техническим развитием или усовершенствованиями. Перед монтажом приведенных в данном каталоге запасных частей необходимо проконтролировать, соответствуют ли эти детали запланированному назначению. Для этих целей в любое время в Вашем распоряжении находится наша техническая служба. В случае возникновения сомнений необходимо получить консультацию. Мы особо указываем на то, что монтаж всех запасных частей должен осуществляться специально обученный персонал.

2. Указания в отношении авторских прав и прав на торговый знак

Авторские права на созданные нами тексты, графические изображения и фотографии остаются исключительно за нами. Любое последующее копирование, размножение или использование этих объектов права в других печатных или электронных средствах информации или публикациях разрешается только при наличии письменного разрешения с нашей стороны и с обязательным указанием источника.

3. Общие условия заключения торговых сделок

Мы особо указываем на то, что все поставки осуществляются исключительно в соответствии с нашими общими условиями продаж и поставок. Действующая формулировка наших общих условий продаж и поставок опубликована на нашем сайте: www.elring.de/agb_en

По Вашему желанию мы можем их выслать Вам.

4. Прочие положения

Названия, описания, номера транспортных средств и производителей и иные похожие сведения приводятся исключительно для целей внутреннего сопоставления. То же самое относится к оригинальным номерам запчастей и комплектовующих производителей транспортных средств и двигателей. Такие сведения не являются обозначениями происхождения и не могут каким-либо образом использоваться в отношении владельцев транспортных средств. С опубликованием данного каталога все предыдущие его издания теряют свою силу.



Website



YouTube



Online Catalog



Instagram

ElringKlinger AG | Aftermarket Division
Max-Eyth-Straße 2 | 72581 Dettingen/Erms | Germany
Phone +49 7123 724-799 | Fax +49 7123 724-798
service@elring.com | www.elring.com



C810051 1021 EN