



Elektrische Ventile  
Electric valves  
Clapets électriques  
Válvulas electricas  
Valvole elettriche

Catalogue  
**2004**





# 2004

ELEKTRISCHE VENTILE

ELECTRIC VALVES

CLAPETS ÉLECTRIQUES

VÁLVULAS ELECTRICAS

VALVOLE ELETTRICHE

<b>D</b>	Grundlagen	Seite	2
	Hauptanwendungen	Seite	9
	Hersteller / Produktanwendungen	Seite	17
	Referenzlisten	Seite	61
<hr/>			
<b>GB</b>	Basics	Page	2
	Main applications	Page	9
	Manufacturers / Product applications	Page	17
	Cross referrence	Page	61
<hr/>			
<b>F</b>	Généralités	Page	2
	Applications principales	Page	9
	Constructeurs / Applications de produits	Page	17
	Liste de comparaison	Page	61
<hr/>			
<b>E</b>	Fundamentos	Página	2
	Aplicaciones principales	Página	9
	Fabricantes / Aplicaciones de productos	Página	17
	Lista de comparación	Página	61
<hr/>			
<b>I</b>	Fondamenta	Pagina	2
	Applicazioni principali	Pagina	9
	Produttori / Applicazioni di prodotti	Pagina	17
	Lista di comparazione	Pagina	61

**D** Wichtige Hinweise

Die Angaben in diesem Katalog sind sorgfältig bearbeitet, aber unverbindlich. Für die Richtigkeit dieser Angaben übernehmen wir keine Gewähr. Insbesondere können Änderungen der Ausrüstung durch die Fahrzeughersteller bzw. Änderungen der Bezeichnungen nicht ausgeschlossen werden. Bitte erkundigen Sie sich gegebenenfalls bei unserem Technischen Kundenservice. Informationen über eventuelle Fehler im Katalog sind uns stets willkommen und werden in den zukünftigen Ausgaben korrigiert. Namen, Beschreibungen und Nummernangaben von Fahrzeugen oder Herstellern u. ä. sind nur zu Vergleichszwecken aufgeführt. Die im Katalog aufgeführten Teile sind Ersatzteile in PIERBURG-Qualität, jedoch keine Originalteile. Abbildungen,

Schemazeichnungen und andere Angaben dienen der Erläuterung und Darstellung und können nicht als Grundlage für Einbau oder Lieferumfang verwendet werden. Dies gilt insbesondere für Herstellerangaben. Angaben über Original-Ersatzteilnummern der Fahrzeughersteller dienen nur zu Vergleichszwecken. Sie sind keine Herkunftsbezeichnungen und dürfen gegenüber Dritten nicht verwendet werden. Für die Anwendung der Vergleichslisten können wir insbesondere wegen möglicher Änderungen und/oder Maßdifferenzen der einzelnen Hersteller keine Haftung übernehmen. Soweit der Katalog Artikel beinhaltet, die nicht von MSI hergestellt wurden, stammen die Produktangaben und Daten vom jeweiligen Hersteller. Es wird keine Haftung

übernommen für die Richtigkeit der Daten und dass das Produkt für den beabsichtigten Verwendungszweck geeignet ist. Um dies sicherzustellen, ist in jedem Fall vor Einbau der fachkundige Rat des Herstellers oder dessen autorisierter Vertragswerkstatt einzuholen. Nachdruck, Nachahmung und Vervielfältigung, auch auszugsweise, ist nur mit unserer schriftlichen Genehmigung und mit Quellenangabe gestattet. Mit Erscheinen dieses Kataloges verlieren frühere Ausgaben ihre Gültigkeit.

Änderungen vorbehalten.

**GB** Important information

The information provided in this catalogue has been carefully compiled, but we should emphasize that it is non-committing. We do not give any warranty for the correctness of this data. Particularly we do not undertake any warranty for changes in the equipment by the manufacturers of vehicles nor for changes in the designation of the parts. In case of doubt you are requested to contact our Technical Customer Service. Any references to errors in the catalogue which you may advise are welcome and will lead to corrections in future issues of the catalogue. Names, descriptions, numbers of vehicles or manufacturers etc. are only stated for reference. All products in the catalogue are spare parts of Pierburg-quality, but no OE-parts. All

figures, schematic drawings and other data serve for explanatory and for illustration purposes only; hence they must not be used as a basis for installation work or scope of supply. Information and data relating to original spare parts numbers of vehicle manufacturers only serve for comparison and reference. They are not to be regarded as designations of origin and must not be used towards third parties. We do not undertake any liability for the application of these reference lists, not least because they may be subject to changes and/or dimensional variances by the individual manufacturers. Inasmuch as the catalogue includes articles not produced by MSI, the product characteristics and data originate from the respective manufacturer. Liability for the correctness

of the data and suitability of the product for the intended purpose of application is expressly excluded. In order to safeguard suitability, it is in each specific case essential to obtain expert advice from the manufacturer or its authorized repair shop. Any reprint, imitation and reproduction, even as excerpts, shall be subject to our prior approval in writing with exact indication of the source. The publication of this catalogue renders all former issues obsolete.

Subject to change without notice.

**F** Note importante

Les informations et données réunies dans ce catalogue ont fait l'objet d'un travail méticuleux, mais n'engagent pas notre responsabilité. Nous ne répondons pas des modifications apportées à nos produits ou à leurs désignations par les constructeurs automobiles. En cas de doute, veuillez vous adresser à notre service après-vente technique. De même, toutes notifications d'erreurs éventuelles relevées dans ce catalogue seront bienvenues, elles seront corrigées dans les versions futures. Les noms, les descriptions et les numéros de véhicules ou de constructeurs, etc. figurant dans ce catalogue ne sont donnés qu'à des fins de comparaison. Les pièces mentionnées dans ce catalogue sont des pièces de rechange de qua-

lité Pierburg, mais ne sont pas d'origine. Les représentations, les dessins schématiques et autres éléments sont destinés à expliquer et à illustrer nos produits et ne peuvent en aucun cas servir de base à l'installation des pièces ou à la définition des étendues de fournitures. Les numéros de pièces détachées d'origine utilisés par les fabricants de véhicules ne s'entendent qu'à des fins de comparaison. Ils ne constituent pas des désignations de provenance et ne doivent pas être utilisés dans les rapports avec des tiers. De ce fait, le contenu des listes comparatives ne saurait engager notre responsabilité, notamment en raison des modifications éventuellement apportées par les fabricants et/ou que des écarts de dimension pouvant exister entre l'un et

l'autre. Dans la mesure où ce catalogue contient des articles qui n'ont pas été fabriqués par MSI, c'est de leurs fabricants que proviennent les informations et données fournies. Nous ne répondons pas de l'exactitude de ces informations et données ni de l'aptitude des produits à la finalité prévue. Afin de vous en assurer, veuillez, avant de les installer, prendre contact avec le fabricant ou l'un de ses concessionnaires autorisés qui sauront vous conseiller en expert. Toute copie ou reproduction, intégrale ou partielle, faite sans notre consentement écrit et sans indication de source, est illicite. La présente édition remplace et annule toutes les éditions précédentes.

Modifications réservées.

**E** Nota importante

Aunque preparados concienzudamente, las informaciones y datos recogidos en este catálogo se entienden sin compromiso. Está excluida toda reclamación de indemnización relacionada con ellos. No respondemos de las modificaciones aportadas a nuestros productos o a sus designaciones por los fabricantes de automóviles. En caso de duda, diríjase a nuestro departamento técnico de posventa. Será bienvenida toda comunicación de eventuales errores, los cuáles serán corregidos en futuras versiones. Los nombres, descripciones y números de automóviles o fabricantes etc. que aparecen en este catálogo, sólo se indican para fines de comparación. Las piezas reunidas en el catálogo son repuestos de calidad PIERBURG, pero no

repuestos originales de las marcas automóviles. Las representaciones, dibujos esquemáticos y otros datos sirven para explicar e ilustrar nuestros productos no se pueden tomar, en ningún caso, como base para la instalación de piezas, la definición de alcances de suministro o el diseño. Los números de repuesto original utilizados por fabricantes de automóviles que aparecen en el presente catálogo se entienden únicamente a título de comparación. No se trata de designaciones de procedencia ni se deben utilizar frente a terceros. Por tanto, no respondemos del contenido de las listas comparativas, sobre todo por los cambios eventualmente efectuados por los fabricantes y/o por las variaciones de dimensiones que pueda haber entre los diferentes fabri-

cantes. En la medida en que este catálogo contiene artículos no fabricados por MSI, la información y los datos facilitados sobre ellos proceden de sus fabricantes. No nos responsabilizamos de su exactitud ni de la idoneidad de los productos para la finalidad prevista. Para ello, debe usted contactar al fabricante o uno de sus concesionarios oficiales que sabrán darle toda la información necesaria. Copias o reproducciones integrales o parciales realizadas sin nuestro consentimiento escrito y sin indicación de la fuente, son ilícitas. La presente versión sustituye y anula todas las versiones anteriores.

Queda reservado el derecho a modificaciones sin previo aviso.

**I** Avvisi importanti

Tutte le informazioni presenti in questo catalogo, sono trattate in modo accurato, ma non vincolanti. Per l'esattezza di queste indicazioni non ci assumiamo alcuna responsabilità. In particolare non possono essere escluse modifiche della dotazione ad opera dei produttori degli autoveicoli o modifiche delle denominazioni. All'occorrenza si prega di contattare il nostro Servizio clienti tecnico. Informazioni su eventuali errori riscontrati nel catalogo, sono sempre ben accetti e saranno corretti nelle prossime edizioni. Nomi, descrizioni e numerazioni sugli autoveicoli, produttori o sim., sono riportati solo per scopi di confronto. I pezzi riportati nel catalogo sono pezzi di ricambio in qualità PIERBURG, ma non si tratta di pezzi originali. Figure, schemi ed altre

indicazioni servono come spiegazione e l'illustrazione e non possono essere impiegati come base per il montaggio o fornitura. Questo vale in particolare per le indicazioni del produttore. Le indicazioni sui codici dei pezzi di ricambio originali dei produttori di autoveicoli servono solo a scopo di confronto. Non rappresentano delle denominazioni di provenienza e non possono essere impiegati nei confronti di terzi. A causa di possibili venature e/o differenze di misura dei singoli produttori, non ci possiamo assumere alcuna responsabilità nel caso in cui si utilizzino elenchi di confronto. Se il catalogo comprende degli articoli non prodotti da MSI, le indicazioni sul prodotto ed i dati sono stati forniti dal relativo produttore. Non ci assumiamo alcuna

responsabilità per la correttezza dei dati e che il prodotto sia adatto per la destinazione d'uso che s'intende praticare. Per una maggiore sicurezza, prima del montaggio è in ogni caso necessario contattare il produttore o un'officina autorizzata. Una ristampa, imitazione ed una riproduzione, anche parziale, sono consentiti solo con una nostra autorizzazione scritta e con l'indicazione delle fonti. Con la pubblicazione del presente catalogo, i precedenti perdono la loro validità.

Con riserva di modifiche.

**D Qualitätsmanagement**

PIERBURG-Erzeugnisse zeichnen sich durch hohe Präzision aus, die durch professionelle Produkt- und Prozessentwicklung, moderne Fertigungsmethoden und umfassende Kontrollen erreicht wird. Unser Qualitätsmanagement ist nach ISO 9001: 2000 und ISO / TS 16949: 2002 zertifiziert und wird ständig weiterentwickelt. Sollte trotz der laufend durchgeführten Kontrollen während des Produktionsprozesses und der gründlichen Endkontrolle ein Material- oder Fertigungsfehler auftreten, übernehmen wir selbstverständlich innerhalb der Verjährungsfrist entweder die Instandsetzung des Motors oder den Ersatz des beanstandeten Pierburg-Erzeugnisses. Derartige Beanstandungen müssen uns binnen einer Frist von

30 Tagen nach Auftreten des Schadens schriftlich mitgeteilt werden. Die Verjährungsfrist für Mängelansprüche beträgt 24 Monate, gerechnet ab Ablieferung der Sache. Mängelansprüche erlöschen, wenn der Liefergegenstand von fremder Seite oder durch Einbau von Teilen fremder Herkunft verändert wird, es sei denn, dass der Mangel nicht in ursächlichem Zusammenhang mit der Veränderung steht. Sie erlöschen weiter, wenn Handhabung und Einbau nach geltender Vorschrift nicht befolgt wurde. Normaler Verschleiß und Beschädigung durch unsachgemäße Behandlung sind von der Gewährleistung ausgeschlossen.

**GB Quality Management**

A distinguished feature of PIERBURG products is their high level of precision, achieved by professional product and process development, modern manufacturing methods and extensive inspections. Our quality management is certified in line with ISO 9001: 2000 and ISO / TS 16949: 2002, and is being continuously improved. If, however, a material or manufacturing defect should occur in spite of the continuous inspections and final inspections carried out, we will of course either undertake to repair the engine or replace the defective PIERBURG product. Complaints of this nature must be communicated to us in writing within a period of 30 days after the occurrence of the damage. The limitation period for

the right to claim a defect shall be of 24 months starting from delivery of the item. These rights of claim for defects are invalidated if the item supplied is modified by another party or by the assembly of parts from another source, unless the defect has no causal relationship with the modification. They will also cease if the applicable handling and assembly specifications are not complied with. The warranty excludes normal wear and damage caused by improper handling.

**F Gestion de la qualité**

Les produits PIERBURG se distinguent par leur haute précision, obtenue grâce au développement professionnel des produits et procédés que nous pratiquons, aux méthodes de fabrication modernes que nous mettons en oeuvre et aux contrôles très complets que nous effectuons. Notre système de gestion de la qualité est certifiée selon ISO 9001: 2000 en ISO / TS 16949: 2002, et nous ne cessons de le faire évoluer. Si, en dépit des contrôles effectués tout au long du processus de production et du rigoureux contrôle final, un défaut de matériau ou de fabrication apparaissait sur un produit, nous prendrons en charge, durant la période de prescription, ou bien la remise en état du moteur ou bien le remplacement du produit vicié. Les réclamations

pour vices doivent nous parvenir par écrit dans un délai de 30 jours suivant la date à laquelle le défaut a été constaté. La période de prescription concernant les réclamations pour vices est de 24 mois, à compter de la date de livraison des pièces PIERBURG concernées. Toute réclamation pour vices est exclue, si les pièces ont été modifiées par des tiers ou par incorporation de pièces provenant de tiers, sauf lorsqu'il n'existe pas de rapport de cause à effet entre le défaut et les modifications apportées. Il en est de même, si les pièces n'ont pas été manipulées et montées conformément aux instructions fournies. Notre garantie ne couvre pas l'usure normale et tout endommagement dû à des conditions d'utilisation impropre.

### **E** Gestión de calidad

Los productos de PIERBURG destacan por su alta precisión, conseguida gracias a un desarrollo profesional de productos y procesos, modernos métodos de fabricación y amplios controles. Nuestro sistema de gestión de calidad está certificado según ISO 9001: 2000 y ISO / TS 16949: 2002 y es constantemente completado y mejorado. Si, a pesar de los controles efectuados a lo largo del proceso de producción y del riguroso control final, apareciera un defecto de material o fabricación en algún producto nuestro, nos encargaremos, dentro del periodo de prescripción, o bien del reacondicionamiento del motor o bien de la sustitución del producto afectado. Las reclamaciones por defectos se nos deben comunicar por escrito

dentro de un plazo de 30 días, contados desde la aparición del defecto. El periodo de prescripción para reclamaciones por defectos es de 24 meses, contados desde la fecha de entrega del producto. Reclamaciones por defectos están excluidas, si el producto ha sido modificado por terceros o por incorporación de piezas procedentes de terceros, salvo que no haya una relación causal entre el defecto y la modificación efectuada. Lo mismo se aplica, si el producto no se ha manipulado e instalado en conformidad con las instrucciones facilitadas. Nuestra garantía no cubre el desgaste normal ni daños resultantes de condiciones de utilización inadecuadas.

### **I** Gestione qualità

I prodotti PIERBURG si caratterizzano per l'elevata precisione ottenuta con uno sviluppo professionale del prodotto e dei processi, metodi di produzione moderni e controlli completi. La nostra gestione di qualità è certificata ISO 9001: 2000 ed ISO / TS 16949: 2002 e viene costantemente sviluppata. Se nonostante i controlli effettuati continuamente durante il processo di produzione e l'accurato controllo finale si dovesse presentare un errore di materiale o di produzione, ovviamente entro il termine di prescrizione ci assumiamo l'onere di riparare il motore o di sostituire il prodotto Pierburg contestato. Tali contestazioni ci devono essere comunicati per iscritto entro 30 giorni dall'avvenimento del danno. Il termine

di prescrizione per i diritti di reclamo sui vizi è di 24 mesi, a decorrere dalla data di fornitura del prodotto. I diritti di reclamo sui vizi si annullano quando l'oggetto di fornitura è stato modificato da terzi o col montaggio di pezzi di aziende terze, a meno che il difetto non sia in correlazione causale con la modifica. Si annullano inoltre quando l'uso ed il montaggio non sono stati eseguiti secondo le normative in vigore. Dalla garanzia sono esclusi la normale usura o il danneggiamento per uso improprio.

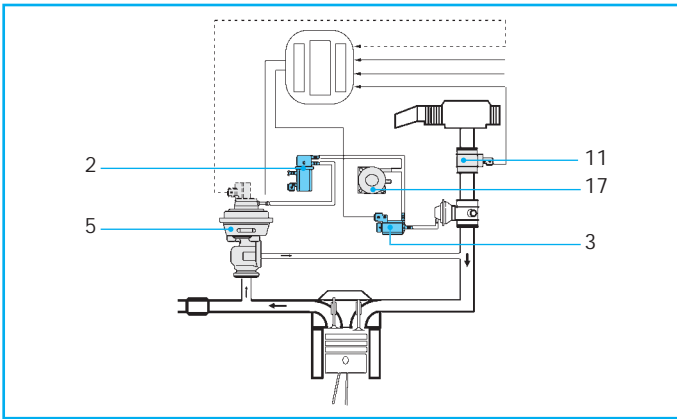

**AGR-Systeme**  
**EGR-systems**  
**Systèmes de recyclage des gaz**  
**Sistemas de recirculación de gases**  
**Sistemi de ricirculazione dei gas di scario**  
 (Fig. 1, 2, 3)

Figure 1  
 AGR-System (Diesel-Motor)  
 EGR-System (Diesel Engine)  
 Système de recyclage (moteur diesel)  
 Sistema de recirculación (motor diesel)  
 Sistema de ricirculazione (motore diesel)

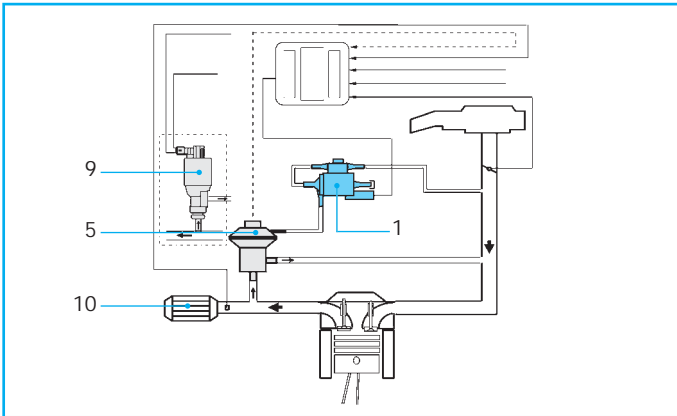

Figure 2  
 AGR-System (Otto-Motor)  
 EGR-System (Otto Engine)  
 Système de recyclage (moteur à essence)  
 Sistema de recirculación (motor de gasolina)  
 Sistema de ricirculazione (motore a benzina)

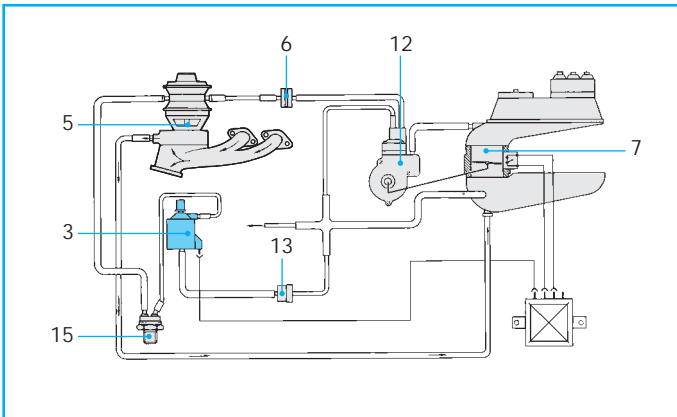

Figure 3  
 AGR-System (mit mech. Druckwandler)  
 EGR-System (with mech. pressure transformer)  
 Système de recyclage (avec convertisseur de pression)  
 Sistema de recirculación (con convertidor de presión)  
 Sistema de ricirculazione (con convertitore di pressione)

Pos.	<b>D</b>	<b>GB</b>	<b>F</b>
1	El.-Druckwandler (EDW)	Electric pressure transducer	Convertisseur de pression électrique
2	El.-Pneum. Druckwandler (EPW)	Electropneumatic transmitter	Convertisseur électropneumatique
3	El. Umschaltventil (EUUV)	Electric switch over valve	Valve de commutation électrique
4	Abschaltventil	Cut-off valve	Clapet de coupure
5	AGR-Ventil	EGR valve	Valve de recyclage
6	Dämpfer	Damper	Amortisseur
7	Drosselklappenstutzen	Throttle body	Boîtier papillon
8	El. Sekundärluft-Pumpe (SLP)	Electric secondary-air pump	Pompe à air secondaire électrique
9	El.AGR-Ventil	Electric EGR valve	Valve de recyclage électrique
10	Katalysator	Catalytic converter	Catalysateur
11	Luftmassensensor (LMS)	Air mass sensor	Débimètre massique d'air
12	Mech. Druckwandler (DW)	Pressure transformer	Convertisseur de pression
13	Rückschlagventil	Non-return valve	Clapet anti-retour
14	SLS-Ventil	Secondary-air intake valve	Valve d'air secondaire
15	Thermoventil	Therموvalve	Thermo-valve
16	Turbolader (VTG-Lader)	Supercharger	Turbocompresseur
17	Vakuumpumpe	Vacuum pump	Pompe à vide

**Sekundärluft-Systeme**  
**Secondary air systems**  
**Systèmes d'air secondaire**  
**Sistemas de aire secundario**  
**Sistemi di aria secondaria**

(Fig. 4, 5)

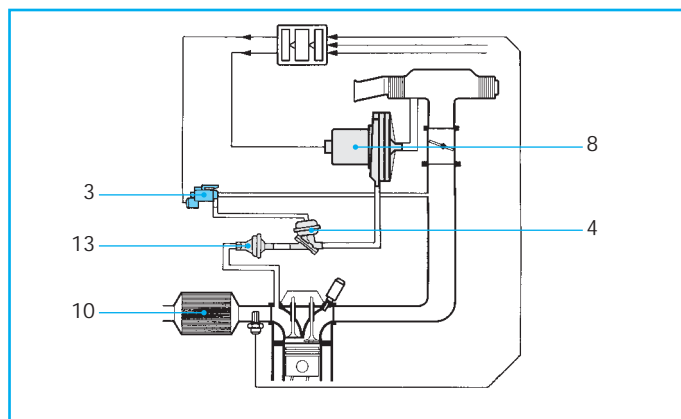

Figure 4

SL-System (mit Sekundärluft-Pumpe)  
 Secondary air system (with secondary-air pump)  
 Système d'air secondaire (avec pompe à air secondaire)  
 Sistema de aire secundario (con bomba de aire secundario)  
 Sistema di aire secondaria (con pompa aria secondaria)

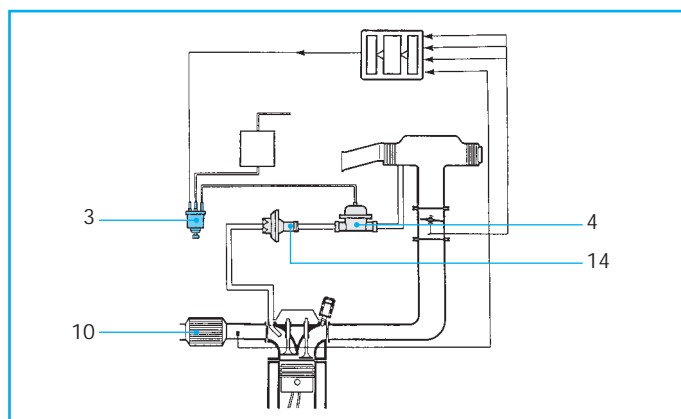

Figure 5

SL-System (mit SLS-Ventil)  
 Secondary air system (with secondary-air intake valve)  
 Système d'air secondaire (avec valve d'air secondaire)  
 Sistema de aire secundario (con válvula de aire secundario)  
 Sistema di aire secondaria (con valvola di aria secondaria)

**Turbolader**  
**Supercharger**  
**Turbocompresseur**  
**Turboalimentador**  
**Turbocompressore**

(Fig. 6/7)

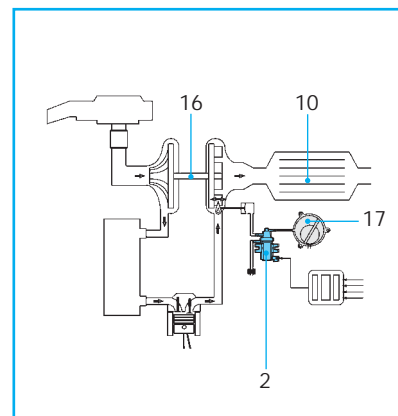
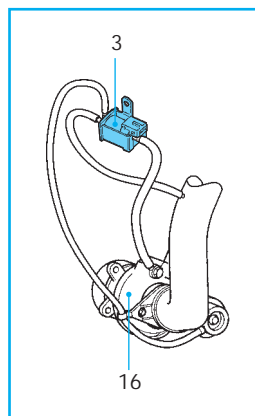

Figure 6/7

Ladedruckregelung / Turbolader (VTG)  
 Boost control / Supercharger  
 Commande de pression d'alimentation / Turbocompresseur  
 Regulación de presión de alimentación / Turboalimentador  
 Regolazione di pressione d'alimentazione / Turbocompressore

Pos.	<b>E</b>	<b>I</b>
1	Transformador eléctrico de presión	Convertitore di pressione elettrico
2	Convertidor electroneumático	Convertitore elettropneumatico
3	Válvula eléctrica de inversión	Valvola di commutazione elettrica
4	Válvula de desconexión	Valvola d'interruzione
5	Válvula de recirculación	Valvola EGR
6	Amortiguador	Ammortizzatore
7	Tubuladura de la válvula mariposa	Manicotto della valvola a farfalla
8	Bomba eléctrica de aire secundario	Pompa elettrica aria secondaria
9	Válvula eléctrica EGR	Valvola EGR elettrica
10	Catalizador	Catalizzatore
11	Sensor de masa de aire	Sonda della massa dell'aria
12	Manómetro de presión/depresión	Convertitore di pressione
13	Válvula de retención	Valvola antiritorno
14	Válvula SLS	Valvola SLS
15	Termoválvula	Valvola termostatica
16	Turboalimentador	Turbocompressore
17	Bomba de vacío	Pompa del vuoto

**D** Katalog-Aufbau

Im folgenden werden Hinweise zum Aufbau des Produktprogrammes gegeben. Bitte beachten Sie außerdem die wichtigen Hinweise am Anfang des Kataloges.

**GB** Catalogue structure

Instructions for using the product program are provided below. Please refer also to the important instructions at the beginning of the catalogue.

**F** Structure du catalogue

Ci-après les instructions pour l'utilisation de la gamme. Veuillez également respecter les «Remarques importantes» mentionnées au début de ce catalogue.









**E** Estructura del catálogo

A continuación se dan instrucciones para el uso del catálogo. Sírvanse leer también la "Nota importante" al principio del catálogo.

**I** Struttura catalogo

Di seguito saranno fornite informazioni relative all'uso del catalogo. Si prega inoltre di osservare le importanti avvertenze riportate all'inizio del catalogo.

<b>D</b> Fahrzeug / Motor	Baujahr von → bis	Pierburg Nr.	Artikel-Code	Info / Kriterien
<b>GB</b> Vehicle / Engine	Model year from → to	Pierburg No.	Product code	Information / remarks
<b>F</b> Véhicule / Moteur	Année de construction de → à	No. Pierburg	Code d'article	Indications / notes
<b>E</b> Vehículos / Motores	Año de construcción desde → hasta	No. Pierburg	Código producto	Información / notas
<b>I</b> Veicolo / Motore	Anno costruzione dal → al	N. Pierburg	Codice articolo	Info / Criteri

<b>ALFA ROMEO</b>		<b>PIERBURG</b>				
<b>A</b>						
<b>ALFA 156</b> <span style="float: right;"><b>1</b></span>						
156 2.4 JTD 103 kW (140 PS) 839 A6.000		10.1997 → 12.2001	7.21903.48.0	DW	 ABC, XYZ	
<b>ALFA 166</b> <span style="float: right;"><b>2</b></span>						
166 2.4 JTD 103 kW (140 PS) AR 36202		10.1998 →	7.21903.48.0	DW	 S, CH	

**D** Artikel-Kürzel  
Beispiel:  
DW = Druckwandler (Erläuterungen siehe Umschlag-Innenseite)

**E** Abreviatura del artículo  
Ejemplo:  
DW = convertidor de presión (para más información ver cara interior de la cubierta)

**GB** Abbreviations  
Example:  
DW = pressure transducer (for explanations, see inside cover)

**I** Abbreviazione articolo  
Esempio:  
DW = Convertitore di pressione (per spiegazioni consultare l'interno della copertina)

**F** Abréviation de l'article  
Exemple :  
DW = convertisseur de pression (pour plus d'informations voir face intérieure de la couverture)



**(D)** Hauptanwendungen

---

**(GB)** Main applications

---

**(F)** Applications principales

---

**(E)** Aplicaciones principales

---

**(I)** Applicazioni principali





# MAIN APPLICATIONS

MAIN APPLICATIONS

4.07501.50.0



LLR

**OPEL**

- ASTRA F
- ASTRA G
- CORSA A
- CORSA B
- KADETT E
- VECTRA A
- VECTRA B
- VAUXHALL**
- ASTRA F
- ASTRA G
- VECTRA

7.12977.51.0



UAV

**BMW**

- 320 - M 535 (E12)

7.20975.66.0



EUV

**OPEL**

- CORSA B
- OMEGA A
- SENATOR B
- VECTRA A
- VECTRA B

7.20229.50.0



UAV

**MERCEDES-BENZ**

- 200
- 230

7.21071.50.0



EUV

**DAEWOO-SSANGYONG**

- CHAIRMAN
- KORANDO
- MUSSO
- REXTON

4.07501.51.0



LLR

**OPEL**

- CORSA A
- CORSA B
- KADETT E

7.20271.52.0



UAV

**VOLVO**

- 240
- 740

**MERCEDES-BENZ**

- C-Klasse
- E-Klasse
- G-Klasse
- S-Klasse
- SL-Klasse
- SPRINTER
- VARIO

4.07501.52.0



LLR

**AUDI**

- AUDI A4
- AUDI A4 QUATTRO
- AUDI A6
- AUDI A6 QUATTRO
- AUDI COUPÉ
- AUDI COUPÉ QUATTRO
- AUDI 80
- AUDI 80 QUATTRO
- AUDI 100
- AUDI 100 QUATTRO

7.20524.50.0



UAV

**MERCEDES-BENZ**

- 250
- 280
- 2t-Serie
- 3t-Serie

190

200

230

250

280

300

320

400

450

500

**VOLKSWAGEN**

LT

7.20733.51.0



UAV

**FIAT / IVECO**

- PUNTO

**MERCEDES-BENZ**

- 190
- 200



# MAIN APPLICATIONS

7.21239.50.0



**EUV**

**AUDI**

AUDI 100  
AUDI 100 QUATTRO  
AUDI 200  
AUDI 200 QUATTRO

7.21704.50.0



**EUV**

**AUDI**

AUDI A3  
AUDI A3 QUATTRO  
AUDI A4  
AUDI A4 QUATTRO  
AUDI A6  
AUDI A6 QUATTRO  
AUDI A8  
AUDI S3  
AUDI TT ROADSTER  
AUDI 100  
AUDI 100 QUATTRO

**VOLKSWAGEN**

BORA  
GOLF I  
GOLF II  
GOLF IV  
GOLF V  
PASSAT

7.21895.55.0

INCA  
LEON  
TOLEDO  
**SKODA**  
FABIA  
OCTAVIA  
**VOLKSWAGEN**  
BORA  
CADDY  
GOLF III  
GOLF IV  
NEW BEETLE  
PASSAT  
POLO  
SHARAN  
VENTO

7.21483.54.0



**DW**

**AUDI**

AUDI A4  
AUDI A4 QUATTRO  
AUDI A6  
AUDI COUPÉ  
AUDI COUPÉ QUATTRO  
AUDI 80  
AUDI 90  
AUDI 90 QUATTRO  
AUDI 100  
AUDI 100 QUATTRO

**VOLKSWAGEN**

GOLF III

7.21903.10.0



**DW**

**OPEL**

ASTRA G  
CORSA C

**VAUXHALL**

ASTRA MK IV  
CORSA

7.21798.83.0



**AKF**

**AUDI**

AUDI A4  
AUDI A4 QUATTRO  
AUDI A8

7.21903.12.0



**DW**

**OPEL**

ASTRA G  
CORSA C

**VAUXHALL**

ASTRA MK IV  
CORSA

7.21493.50.0



**EUV**

**FIAT / IVECO**

PUNTO

7.21895.55.0



**EUV**

**AUDI**

AUDI A2  
AUDI A3  
AUDI A4  
AUDI A6  
AUDI CABRIOLET

**FORD**

GALAXY

**SEAT**

ALHAMBRA  
CORDOBA  
IBIZA

7.21903.33.0



**DW**

**ROVER**

RANGE ROVER

7.21681.51.0



**LDRV**

**VOLVO**

850

MAIN APPLICATIONS



# MAIN APPLICATIONS

MAIN APPLICATIONS

7.21903.44.0



DW

**VOLVO**  
S 40  
V 40

7.21903.51.0



DW

**AUDI**  
AUDI A6  
AUDI A6 QUATTRO  
AUDI A8

7.21903.75.0



DW

**AUDI**  
AUDI A2  
AUDI A3  
AUDI A4  
AUDI A4 QUATTRO  
AUDI A6

7.21903.48.0



DW

**ALFA ROMEO**  
ALFA 156  
ALFA 166  
**LANCIA**  
LYBRA

7.21903.70.0



DW

**AUDI**  
AUDI A2  
AUDI A3  
AUDI A4  
AUDI A4 QUATTRO  
AUDI A6  
AUDI A6 QUATTRO  
AUDI CABRIOLET

**FORD**  
GALAXY  
**SEAT**  
ALHAMBRA  
CORDOBA  
IBIZA  
LEON  
TOLEDO  
**SKODA**  
OCTAVIA  
**VOLKSWAGEN**  
BORA  
GOLF III  
GOLF IV  
LUPO  
PASSAT  
POLO  
SHARAN  
TRANSPORTER T4  
VENTO

7.21903.49.0



DW

**AUDI**  
AUDI A6  
AUDI A6 QUATTRO  
AUDI A8

**FORD**  
GALAXY  
**VOLKSWAGEN**  
BORA  
CADDY  
GOLF III  
GOLF IV  
LT  
LUPO  
PASSAT  
POLO  
SHARAN  
TRANSPORTER T4  
VENTO

7.21911.83.0



EUV

**BMW**  
316 - M3 (E36)  
316 - M3 (E46)  
518 - M5 (E34)

7.21903.50.0



DW

**ROVER**  
LAND ROVER DEFENDER  
LAND ROVER DISCOVERY

7.21903.73.0



DW

**BMW**  
316 - M3 (E36)  
518 - M5 (E34)  
515 - M5 (E39)  
725 - 750 (E38)  
**OPEL**  
OMEGA B



# MAIN APPLICATIONS

7.21980.50.0



**VOLVO**  
850

**EUV**

7.22293.03.0



**EUV**

**OPEL**  
ASTRA F  
CALIBRA  
VECTRA B  
**VAUXHALL**  
ASTRA F

7.22341.08.0

840 - 850 (E31)  
Z 3 (E36/7)  
Z 8 (E52)

7.22355.01.0



**EUV**

**MERCEDES-BENZ**

C-Klasse  
CL-Klasse  
CLK-Klasse  
E-Klasse  
G-Klasse  
ML-Klasse  
S-Klasse  
SL-Klasse  
SLK-Klasse

7.22138.50.0



**EUV**

**OPEL**  
ASTRA F  
VECTRA B  
**VAUXHALL**  
ASTRA F

7.22293.50.0



**EUV**

**OPEL**  
ASTRA F  
CALIBRA  
VECTRA B  
**VAUXHALL**  
ASTRA F

7.22402.50.0



**EUV**

**AUDI**  
AUDI A3  
AUDI A4  
AUDI A4 QUATTRO  
AUDI A6  
**VOLKSWAGEN**  
GOLF IV  
NEW BEETLE  
PASSAT  
POLO

7.22240.08.0



**EUV**

**VOLVO**  
S 40  
V 40  
S 60  
C 70 COUPÉ  
S 80

7.22340.63.0



**EUV**

**BMW**  
518 - M5 (E34)  
515 - M5 (E39)  
725 - 750 (E38)  
X5 (E53)

7.22240.09.0



**EUV**

**VOLVO**  
S 40  
V 40  
S 70  
V 70 I

7.22341.08.0



**EUV**

**BMW**  
316 - M3 (E36)  
316 - M3 (E46)  
515 - M5 (E39)  
725 - 750 (E38)

7.22402.51.0



**EUV**

**AUDI**  
AUDI A6 QUATTRO  
AUDI A8  
AUDI A8 QUATTRO  
AUDI S6  
AUDI S8

MAIN APPLICATIONS



# MAIN APPLICATIONS

MAIN APPLICATIONS

7.22449.02.0



**EUV**

**OPEL**

ASTRA F  
ASTRA G  
ASTRA G CABRIO  
ASTRA G COUPÉ  
VECTRA B  
VECTRA C  
ZAFIRA

7.22517.04.0



**AKF**

**VOLVO**

S 40  
V 40  
S 60  
C 70 COUPÉ  
C 70 Convertible  
S 70  
S 80

7.22566.50.0

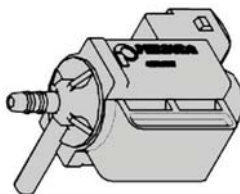

**EUV**

**OPEL**

ASTRA G  
CALIBRA

7.22687.07.0



**EUV**

**AUDI**

AUDI A3  
AUDI A3 QUATTRO

7.22687.07.0

AUDI A6  
AUDI S3  
AUDI S4  
AUDI TT  
AUDI TT QUATTRO  
AUDI TT ROADSTER  
**VOLKSWAGEN**  
BORA  
GOLF IV

7.22796.01.0



**DW**

**BMW**

316 - M3 (E46)  
515 - M5 (E39)  
725 - 750 (E38)

7.22880.01.0



**EUV**

**AUDI**

AUDI A3  
AUDI A4  
AUDI A8  
AUDI S3  
**VOLKSWAGEN**  
BORA  
GOLF IV  
GOLF V  
PASSAT  
PHAETON  
POLO  
TOUAREG  
TOURAN

7.22903.01.0



**DW**

**AUDI**

AUDI A3  
**SEAT**  
ALHAMBRA

7.22903.01.0

LEON  
TOLEDO  
**SKODA**  
OCTAVIA  
**VOLKSWAGEN**  
BORA  
GOLF IV  
NEW BEETLE  
PASSAT  
SHARAN

7.22903.02.0



**DW**

**AUDI**

AUDI A3  
AUDI A4  
**VOLKSWAGEN**  
GOLF IV

7.22903.04.0



**DW**

**AUDI**

AUDI A3  
**VOLKSWAGEN**  
BORA  
GOLF IV  
PASSAT  
SHARAN

7.22903.16.0



**DW**

**AUDI**

AUDI A6 ALLROAD  
AUDI A6 QUATTRO



# MAIN APPLICATIONS

7.22903.17.0



DW

**AUDI**

AUDI A6  
AUDI A6 ALLROAD  
AUDI A6 QUATTRO

7.28148.01.0



EUV

**FIAT / IVECO**

DOBLÒ  
PALIO  
PUNTO  
STILO  
STRADA (USA)

7.22903.18.0



DW

**AUDI**

AUDI A4

7.28328.05.0



DW

**CITROEN**

C3  
C5  
EVASION  
XSARA  
XSARA PICASSO

7.22903.19.0



DW

**AUDI**

AUDI A4  
AUDI A6

**PEUGEOT**

206  
307

7.28098.04.0

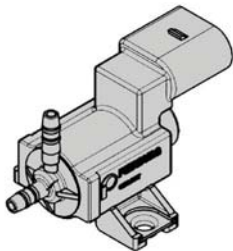

EUV

**AUDI**

AUDI A2  
AUDI A3

**VOLKSWAGEN**

BORA  
GOLF IV  
GOLF V  
LUPO  
PHAETON  
TOUAREG  
TRANSPORTER T4  
TRANSPORTER T5





**(D)** Herstellerverzeichnis

---

**(GB)** List of manufacturers

---

**(F)** Liste des constructeurs

---

**(E)** Lista de fabricantes

---

**(I)** Lista dei produttori





# LIST OF MANUFACTURERS

	Page		Page
<b>A</b>		<b>S</b>	
ALFA ROMEO .....	20	SEAT.....	47
AUDI .....	21	SKODA .....	48
AUSTIN (BLMC)..... → ROVER	46	SOFIM .....	20
		..... → ALFA ROMEO	
		..... → FIAT / IVECO	32
		SSANGYONG .....	31
		..... → DAEWOO-SSANGYONG	
		STEYR .....	36
		..... → MERCEDES-BENZ	
<b>B</b>		<b>T</b>	
BEDFORD..... → OPEL	41	TALBOT..... → PEUGEOT	45
BMW.....	27		
<b>C</b>		<b>U</b>	
CITROEN .....	30	UNIC .....	32
CLAAS .....	34	..... → FIAT / IVECO	
..... → MERCEDES-BENZ	36		
..... → VOLKSWAGEN	50		
<b>D</b>		<b>V</b>	
DAEWOO-SSANGYONG .....	31	VAUXHALL..... → OPEL	41
DAIMLER-CHRYSLER .....	36	.....	49
..... → MERCEDES-BENZ		VOLKSWAGEN .....	50
		VOLVO.....	57
<b>F</b>			
FAHR..... → FORD	34		
..... → MERCEDES-BENZ	36		
..... → VOLKSWAGEN	50		
FAUN..... → FORD	34		
FIAT / IVECO .....	32		
FORD .....	34		
FORDSON .....	34		
<b>H</b>			
HOLDEN .....	41		
..... → VAUXHALL	49		
<b>I</b>			
IKARUS BUDAPEST..... → VOLVO	57		
IVECO..... → FIAT / IVECO	32		
<b>L</b>			
LANCIA.....	35		
LAND-ROVER .....	46		
..... → ROVER			
<b>M</b>			
MERCEDES-BENZ.....	36		
MG..... → ROVER	46		
MINI..... → ROVER	46		
MORRIS..... → ROVER	46		
<b>O</b>			
OM..... → FIAT / IVECO	32		
OPEL.....	41		
<b>P</b>			
PEUGEOT .....	45		
<b>R</b>			
ROVER.....	46		



**(D) Produktanwendungen**

**(GB) Product applications**

**(F) Applications de produits**

**(E) Aplicaciones de productos**

**(I) Applicazioni di prodotti**



A



## ALFA 156

1

**156 2.4 JTD** 103 kW (140 PS)  
839 A6.000

09.2000→12.2001

**7.21903.48.0** DW

## ALFA 166

2

**166 2.4 JTD** 103 kW (140 PS)  
AR 36202

10.2000→

**7.21903.48.0** DW



<b>A2</b>					<b>1</b>
1.2 TDI 45 kW (61 PS) ANY	03.2001→	7.21903.70.0	DW		
		7.21903.75.0	DW		
1.4 TDI 55-66 kW (75-90 PS) AMF, ATL, BHC	06.2000→	7.21895.55.0	EUV		
		7.21903.70.0	DW		
1.6 FSI 81 kW (110 PS) BAD	05.2002→	7.28098.04.0	EUV		
<b>A3</b>					<b>2</b>
1.6 74-75 kW (100-102 PS) AEH, AKL, APF, AVU	09.1996→06.2003	7.22402.50.0	EUV		<b>MOT</b> AEH, AKL, APF: <b>FZG</b> 8L-1-000 001→8L-Y-150 000 <b>MOT</b> AVU: <b>FZG</b> 8L-1-000 001→
1.6 FSI 75-85 kW (102-115 PS) BAG, BGU	05.2003→	7.21704.50.0	EUV		
		7.22880.01.0	EUV		
		7.28098.04.0	EUV		
1.8 20V 92 kW (125-126 PS) AGN, APG	09.1996→06.2003	7.28098.04.0	EUV		
1.8 20V Turbo 110 kW (150 PS) AGU	12.1996→06.2003	7.21704.50.0	EUV		
1.8 20V Turbo 110-132 kW (150-180 PS) AJQ, APP, AQA, ARX, ARY, ARZ, AUM, AUQ	08.1998→06.2003	7.21704.50.0	EUV		<b>MOT</b> AJQ, APP, AQA, ARZ: →12.2000 <b>MOT</b> ARX, ARY, AUM, AUQ: 01.2001→
		7.22687.07.0	EUV		
1.9 TDI 66 kW (90 PS) AGR	09.1996→08.2000	7.21895.55.0	EUV		
		7.21903.70.0	DW	<b>FZG</b> →8L-X-200 000	
		7.22903.01.0	DW	<b>FZG</b> 8L-Y-000 001→	
1.9 TDI 66 kW (90 PS) ALH	08.1997→06.2001	7.21895.55.0	EUV		
		7.21903.70.0	DW	<b>FZG</b> →8L-X-200 000	
		7.21903.75.0	DW	→12.2000, <b>FZG</b> →8L-X-200 000	
		7.22903.01.0	DW	<b>FZG</b> 8L-Y-000 001→	
		7.22903.04.0	DW	<b>FZG</b> 8L-Y-000 001→	
1.9 TDI 81 kW (110 PS) AHF, ASV	01.1997→04.2002	7.21903.70.0	DW	<b>FZG</b> →8L-X-200 000	
		7.21903.75.0	DW	→12.2000, <b>FZG</b> →8L-X-200 000	
		7.22903.01.0	DW	<b>FZG</b> 8L-Y-000 001→	
		7.22903.04.0	DW	<b>FZG</b> 8L-Y-000 001→	
1.9 TDI 96 kW (130 PS) ASZ	05.2000→06.2003	7.22903.01.0	DW		
		7.22903.02.0	DW		
2.0 FSI 16V 110 kW (150 PS) AXW	05.2003→	7.21704.50.0	EUV		
		7.22880.01.0	EUV		
		7.28098.04.0	EUV		
2.0 TDI 16V 100-103 kW (136-140 PS) AZV, BKD	05.2003→	7.21704.50.0	EUV		
		7.22880.01.0	EUV		
		7.28098.04.0	EUV		
<b>A3 QUATTRO</b>					<b>3</b>
1.8 20V Turbo 110 kW (150 PS) AGU, ARZ, AUM	12.1996→06.2003	7.21704.50.0	EUV		
1.8 20V Turbo 110-132 kW (150-180 PS) AJQ, APP, AQA, ARX, ARY, AUQ	08.1998→06.2003	7.21704.50.0	EUV		
		7.22687.07.0	EUV	<b>MOT</b> AJQ, APP, AQA: →12.2000 <b>MOT</b> ARX, ARY, AUQ: 01.2001→	
<b>A4</b>					<b>4</b>
1.6 74 kW (100 PS) AHL, ANA, ARM	10.1996→09.2001	7.22402.50.0	EUV	01.1999→	
1.8 85 kW (115 PS) AFY	07.1995→09.2001	7.21704.50.0	EUV		
1.8 (MEX) 125 kW (170 PS) AMB	09.2001→06.2002	7.21704.50.0	EUV		
		7.22880.01.0	EUV		
		7.22903.18.0	DW		
		7.22903.19.0	DW		



A4					4
1.8 20V 92 kW (125 PS) ADR	11.1994→04.1999	7.21704.50.0	EUV		01.1999→ MT
		7.22402.50.0	EUV		
1.8 20V 92 kW (125 PS) APT, ARG	07.1998→09.2001	7.22402.50.0	EUV		<b>MOT</b> APT: MT <b>MOT</b> ARG: 01.2000→ AT
1.8 20V Turbo 110 kW (150 PS) ANB, APU, ARK	07.1998→09.2001	7.21704.50.0	EUV		
1.9 TDI 55-66 kW (75-90 PS) AFF, 1Z	01.1995→06.2000	7.21704.50.0	EUV		
		7.21903.70.0	DW		
1.9 TDI 66 kW (90 PS) AHH	04.1997→09.2001	7.21704.50.0	EUV		<b>MOT</b> 1Z: →07.1996
1.9 TDI 66 kW (90 PS) AHU	08.1996→06.2000	7.21704.50.0	EUV		
		7.21895.55.0	EUV		
1.9 TDI 66 kW (90 PS) AHU	08.1996→06.2000	7.21895.55.0	EUV		
		7.21903.70.0	DW		
1.9 TDI 74-96 kW (100-130 PS) AVB, AVF, AWW	12.2000→	7.21704.50.0	EUV		
		7.22903.19.0	DW		
1.9 TDI 81-85 kW (110-115 PS) AFN, AJM, AVG	02.1996→09.2001	7.21704.50.0	EUV		
		7.21903.70.0	DW		
		7.21903.75.0	DW		
1.9 TDI 81-85 kW (110-115 PS) APD, ATJ	01.1995→	7.21704.50.0	EUV		
2.0 FSI 110 kW (150 PS) AWA	07.2002→	7.21704.50.0	EUV		
		7.22880.01.0	EUV		
		7.22903.18.0	DW		
		7.22903.19.0	DW		
2.0 20V 96 kW (131 PS) ALT	12.2000→	7.21704.50.0	EUV		
		7.22880.01.0	EUV		
2.0 TDI 100 kW (136 PS) BGW	11.2003→	7.21704.50.0	EUV		
		7.22880.01.0	EUV		
		7.22903.18.0	DW		
		7.22903.19.0	DW		
2.4 V6 30V 120-121 kW (163-165 PS) AGA, ALF, AML, APS, APZ, ARJ	08.1997→09.2001	7.21704.50.0	EUV		<b>MOT</b> AGA, ALF: →12.1999, <b>FZG</b> →8D x 199 999 <b>MOT</b> AML, APS, APZ, ARJ: 01.1999→, <b>FZG</b> 8D x 200 000→
2.5 V6 TDI 110-132 kW (150-179 PS) AFB, AKN, BAU, BDH	11.1997→	7.21704.50.0	EUV		
2.5 V6 TDI 114-120 kW (155-163 PS) AYM, BCZ, BDG, BFC	04.2001→	7.21704.50.0	EUV		
		7.22903.19.0	DW		
2.5 V6 TDI 125-132 kW (170-179 PS) AKE	12.2000→05.2003	7.21704.50.0	EUV		
		7.22903.02.0	DW		
		7.22903.19.0	DW		
2.5 V6 TDI (F) 110 kW (150 PS) AKN	08.1998→07.1999	7.21704.50.0	EUV		
2.4 V6 110 kW (150 PS) ABC	11.1994→07.1998	4.07501.52.0	LLR		SPi
		7.21798.83.0	AKF		
2.8 V6 128 kW (174 PS) AAH	11.1994→07.1997	7.21483.54.0	DW		01.1996→
		7.21704.50.0	EUV		
		7.21798.83.0	AKF		
2.8 V6 140 kW (190 PS) ATX	03.1999→09.2001	7.21483.54.0	DW		
2.8 V6 30V 142 kW (193 PS) ACK	03.1996→12.1998	7.21704.50.0	EUV		01.1998→, <b>FZG</b> →8D x 199 999
		7.21798.83.0	AKF		
2.8 V6 30V 142 kW (193 PS) ALG, APR, AQD	05.1997→06.2000	7.21704.50.0	EUV		<b>MOT</b> ALG: <b>FZG</b> →8D x 199 999 <b>MOT</b> APR, AQD: 01.1999→, <b>FZG</b> 8D x 200 000→



<b>A4</b>					<b>4</b>
<b>3.0 V6 30V</b> 160-162 kW (218-220 PS) ASN, BBJ	12.2000→	<b>7.22880.01.0</b>	EUV		
<b>3.0 V6 30V (MEX)</b> 160-162 kW (218-220 PS) ASN, AVK, BBJ	07.2002→	<b>7.22880.01.0</b> <b>7.22903.18.0</b> <b>7.22903.19.0</b>	EUV DW DW		
<b>A4 QUATTRO</b>					<b>5</b>
<b>1.8 20V</b> 92 kW (125 PS) ADR	11.1994→07.1997	<b>7.21704.50.0</b> <b>7.22402.50.0</b>	EUV EUV		MT
<b>1.9 TDI</b> 81-85 kW (110-115 PS) AFN, AJM	02.1996→09.2001	<b>7.21903.70.0</b> <b>7.21903.75.0</b>	DW DW		
<b>2.4 V6 30V</b> 120-121 kW (163-165 PS) AJG, AML	08.1998→09.2001	<b>7.21704.50.0</b>	EUV		<b>MOT</b> AJG: <b>FZG</b> →8D x 199 999 <b>MOT</b> AML: <b>FZG</b> 8D x 200 000→
<b>2.6</b> 110 kW (150 PS) ABC	11.1994→07.1997	<b>4.07501.52.0</b>	LLR		SPi
<b>2.8</b> 128 kW (174 PS) AAH	11.1994→07.1997	<b>7.21483.54.0</b> <b>7.21704.50.0</b> <b>7.21798.83.0</b>	DW EUV AKF		01.1996→
<b>2.8 V6 30V</b> 142 kW (193 PS) ACK	03.1996→12.1998	<b>7.21704.50.0</b> <b>7.21798.83.0</b>	EUV AKF		01.1998→, <b>FZG</b> →8D x 199 999
<b>2.8 V6 30V</b> 142 kW (193 PS) ALG, APR, AQD	05.1997→06.2000	<b>7.21704.50.0</b>	EUV		<b>MOT</b> ALG: <b>FZG</b> →8D x 199 999 <b>MOT</b> APR, AQD: <b>FZG</b> 8D x 200 000→
<b>A6</b>					<b>6</b>
<b>1.8 20V</b> 92 kW (125 PS) AJP	12.1997→07.1999	<b>7.21704.50.0</b>	EUV		
<b>1.8 20V</b> 92 kW (125 PS) AQE, ARH	01.1999→	<b>7.22402.50.0</b>	EUV		<b>MOT</b> AQE: →12.2001 MT <b>MOT</b> ARH: →12.2001 AT
<b>1.8 20V Turbo</b> 110 kW (150 PS) ANB, APU, ARK, AWT	11.1998→	<b>7.21704.50.0</b>	EUV		→12.2001
<b>1.9 TDI</b> 66 kW (90 PS) AHU	07.1996→10.1997	<b>7.21895.55.0</b> <b>7.21903.70.0</b>	EUV DW		
<b>1.9 TDI</b> 81-85 kW (110-115 PS) AFN, AJM	04.1997→04.2001	<b>7.21903.70.0</b> <b>7.21903.75.0</b>	DW DW		
<b>1.9 TDI</b> 96 kW (130 PS) AWX	06.2001→	<b>7.22903.19.0</b>	DW		
<b>2.0 20V</b> 96 kW (131 PS) ALT	06.2001→	<b>7.22903.17.0</b>	DW		
<b>2.4 V6 30V</b> 120-121 kW (163-165 PS) AGA, AJG, APS, APZ	04.1997→05.2001	<b>7.21704.50.0</b>	EUV		<b>MOT</b> AGA, AJG: →01.1999 <b>MOT</b> APS, APZ: 11.1998→
<b>2.5 TDI</b> 85-103 kW (115-140 PS) AAT, AEL	06.1994→10.1997	<b>7.21903.70.0</b>	DW		<b>MOT</b> AAT: 01.1997→ <b>MOT</b> AEL: 01.1996→
<b>2.5 V6 TDI</b> 110 kW (150 PS) AFB, AKN	04.1997→05.2001	<b>7.21903.49.0</b> <b>7.21903.51.0</b>	DW DW		
<b>2.5 V6 TDI</b> 114-132 kW (155-179 PS) AYM, BCZ, BDG, BDH, BFC	06.2001→	<b>7.21903.75.0</b>	DW		
<b>2.5 V6 TDI</b> 125-132 kW (170-179 PS) AKE	11.1999→08.2003	<b>7.21903.49.0</b> <b>7.21903.51.0</b> <b>7.21903.75.0</b> <b>7.22903.19.0</b>	DW DW DW DW		→12.2001 →12.2001
<b>2.6 V6</b> 102-110 kW (139-150 PS) ABC, ACZ	06.1994→10.1997	<b>4.07501.52.0</b>	LLR		SPi
<b>2.7 V6 30V</b> 169 kW (230 PS) AJK	02.1999→08.2000	<b>7.22687.07.0</b>	EUV		
<b>2.8</b> 120 kW (163 PS) AEJ	06.1994→10.1997	<b>7.21483.54.0</b> <b>7.21704.50.0</b>	DW EUV		¶ RUS, CDN



## A6 6

<b>2.8 V6</b> 128-140 kW (174-190 PS) AAH, ATX	06.1994→05.2001	<b>7.21483.54.0</b>	DW	
		<b>7.21704.50.0</b>	EUV	
<b>2.8 V6</b> 128 kW (174 PS) AFC	08.1994→06.1995	<b>7.21483.54.0</b>	DW	
<b>2.8 V6 30V</b> 142 kW (193 PS) APR	11.1998→05.2001	<b>7.21704.50.0</b>	EUV	
<b>3.0 V6 30V</b> 160-162 kW (218-220 PS) ASN, BBJ	06.2001→	<b>7.22903.17.0</b>	DW	

## A6 ALLROAD 7

<b>2.7 V6 30V</b> 184 kW (250 PS) ARE, BES	05.2000→	<b>7.22903.16.0</b>	DW	
		<b>7.22903.17.0</b>	DW	
<b>4.2 V8 40V</b> 220 kW (299 PS) BAS	04.2003→	<b>7.22903.16.0</b>	DW	
		<b>7.22903.17.0</b>	DW	

## A6 QUATTRO 8

<b>1.8 20V</b> 92 kW (125 PS) ADR	10.1995→10.1997	<b>7.21704.50.0</b>	EUV	
<b>2.4 V6</b> 120 kW (163 PS) AJG	04.1997→01.1999	<b>7.21704.50.0</b>	EUV	
<b>2.5 TDI</b> 85-103 kW (115-140 PS) AAT, AEL	06.1994→10.1997	<b>7.21903.70.0</b>	DW	<b>MOT</b> AAT: 01.1997→ <b>MOT</b> AEL: 01.1996→
<b>2.5 V6 TDI</b> 110 kW (150 PS) AFB, AKN	04.1997→05.2001	<b>7.21903.49.0</b>	DW	
		<b>7.21903.51.0</b>	DW	
<b>2.5 V6 TDI</b> 125-132 kW (170-179 PS) AKE	11.1999→08.2003	<b>7.21903.49.0</b>	DW	
<b>2.6 V6</b> 110 kW (150 PS) ABC	06.1994→10.1997	<b>4.07501.52.0</b>	LLR	<b>FZG</b> 4A-S-026 715→ SPI
<b>2.7 V6 30V</b> 121 kW (165 PS) APC	05.2000→06.2002	<b>7.22903.16.0</b>	DW	
		<b>7.22903.17.0</b>	DW	
<b>4.2 V8</b> 220 kW (299 PS) ARS, ASG, AWN	04.1999→	<b>7.22402.51.0</b>	EUV	

## A8 9

<b>2.5 V6 TDI</b> 110-132 kW (150-179 PS) AFB, AKE, AKN	06.1997→09.2002	<b>7.21903.49.0</b>	DW	<b>MOT</b> AFB, AKN: 01.1999→
		<b>7.21903.51.0</b>	DW	<b>MOT</b> AFB, AKN: 01.1999→
<b>2.8 V6 30V</b> 142 kW (193 PS) APR	01.1999→02.2001	<b>7.21704.50.0</b>	EUV	
<b>3.0 V6 30 V</b> 160-162 kW (218-220 PS) ASN, BBJ	07.2003→	<b>7.22880.01.0</b>	EUV	
<b>3.0 V6 TDI</b>	11.2003→	<b>7.22880.01.0</b>	EUV	
<b>3.7 V8 40V</b> 191 kW (260 PS) AKC, AQG	10.1998→09.2002	<b>7.22402.51.0</b>	EUV	<b>FZG</b> F 4D-X-005 001→
<b>4.0 V8 TDI</b> 202 kW (275 PS) ASE	05.2003→	<b>7.22880.01.0</b>	EUV	
<b>4.2 V8 32V</b> 220 kW (300 PS) ABZ	06.1994→12.1998	<b>7.21798.83.0</b>	AKF	

## A8 QUATTRO 10

<b>3.7 V8 40V</b> 191 kW (260 PS) AKC, AQG	10.1998→09.2002	<b>7.22402.51.0</b>	EUV	<b>FZG</b> F 4D-X-005 001→
<b>4.2 V8</b> 175 kW (238 PS) ARU	02.1999→04.2000	<b>7.22402.51.0</b>	EUV	<b>FZG</b> F 4D-X-005 001→
<b>4.2 V8 40V</b> 228 kW (310 PS) AQF, AUW	10.1998→09.2002	<b>7.22402.51.0</b>	EUV	<b>FZG</b> F 4D-X-005 001→

## CABRIOLET 11

<b>Audi Cabrio 1.9 TDI</b> 66 kW (90 PS) AHU	07.1996→08.2000	<b>7.21895.55.0</b>	EUV	
		<b>7.21903.70.0</b>	DW	



<b>COUPÉ</b>						<b>12</b>
2.3 20V 125 kW (170 PS) 7A	11.1988→07.1991	7.21483.54.0	DW	09.1989→ USA		
2.6 110 kW (150 PS) ABC	08.1992→12.1995	4.07501.52.0	LLR	SPi		
<b>COUPÉ QUATTRO</b>						<b>13</b>
2.3 20V 125 kW (170 PS) 7A	11.1988→07.1991	7.21483.54.0	DW	USA		
2.6 110 kW (150 PS) ABC	08.1992→12.1995	4.07501.52.0	LLR	SPi		
<b>S3</b>						<b>14</b>
1.8 154 kW (209-210 PS) AMK, APY	11.1998→04.2002	7.21704.50.0 7.22687.07.0 7.22880.01.0	EUV EUV EUV	MOT AMK: 01.2001→ MOT APY: →12.2000		
1.8 154-165 kW (209-225 PS) AUL, BAM	07.1999→06.2003	7.21704.50.0 7.22880.01.0	EUV EUV			
<b>S4</b>						<b>15</b>
2.7 195 kW (265 PS) AGB	10.1997→09.2001	7.22687.07.0	EUV			
<b>S6</b>						<b>16</b>
4.2 V8 40V 250 kW (340 PS) ANK, AQJ	09.1999→	7.22402.51.0	EUV			
<b>S8</b>						<b>17</b>
4.2 V8 40V 265 kW (360 PS) AQH, AVP	05.1999→09.2002	7.22402.51.0	EUV	FZG F 4D-X-005 001→		
<b>TT</b>						<b>18</b>
1.8 20V Turbo 132 kW (180 PS) ARY, AUQ	10.1998→	7.22687.07.0	EUV	→12.2002		
<b>TT QUATTRO</b>						<b>19</b>
1.8 20V Turbo 132 kW (177-180 PS) AJQ, ARY	10.1998→	7.22687.07.0	EUV	→12.2002		
<b>TT ROADSTER</b>						<b>20</b>
1.8 T Quattro 132-165 kW (180-224 PS) APX, ARY	04.1999→	7.21704.50.0 7.22687.07.0	EUV EUV	→12.2002		
1.8 20V Turbo 110-132 kW (150-180 PS) ARY, AUM, AUQ	09.2000→	7.21704.50.0 7.22687.07.0	EUV EUV	→12.2002		
1.8 20V Turbo 132-165 kW (177-225 PS) AJQ, AMU, BAM	04.1999→	7.21704.50.0	EUV			
<b>80</b>						<b>21</b>
1.6 55-81 kW (75-110 PS) DT, RN, WV, YN, YP, YZ	09.1975→12.1991	7.21483.54.0	DW	MOT DT, WV, YN: 09.1981→ S, CH MOT RN: →08.1989 S, CH MOT YP: 09.1978→08.1981 MOT YZ: →08.1980		
1.6 GLE 81 kW (110 PS) YZ	01.1979→07.1982	7.21483.54.0	DW	→08.1980		
1.8 66 kW (90 PS) DS, JN, NE, PM	01.1983→12.1991	7.21483.54.0	DW	MOT DS, JN: G-Kat S, CH MOT NE, PM: →08.1989		



<b>80</b>					<b>21</b>
1.9 TD 55 kW (75 PS) AAZ	09.1991→07.1995	7.21483.54.0	DW		
2.6 V6 110 kW (150 PS) ABC	07.1992→07.1995	4.07501.52.0	LLR	SPI	
<b>80 QUATTRO</b>					<b>22</b>
2.6 110 kW (150 PS) ABC	07.1992→07.1995	4.07501.52.0	LLR	SPI	
<b>90</b>					<b>23</b>
2.3 E 100 kW (136 PS) NG	08.1987→12.1991	7.21483.54.0	DW	" USA	
2.3 E 20 V 125 kW (170 PS) 7A	06.1988→12.1991	7.21483.54.0	DW	" USA	
<b>90 QUATTRO</b>					<b>24</b>
2.3 100 kW (136 PS) NG	08.1987→12.1991	7.21483.54.0	DW	" USA	
2.3 20 V 125 kW (170 PS) 7A	06.1988→12.1991	7.21483.54.0	DW	" USA	
<b>100</b>					<b>25</b>
1.8 E 66 kW (90 PS) 4B	01.1988→12.1990	7.21704.50.0	EUV	FZG 44 J 200 100→	
2.2 Turbo 121 kW (165 PS) MC	08.1986→12.1990	7.21239.50.0	EUV		
2.3 E 97-100 kW (132-136 PS) NF	08.1986→12.1990	7.21483.54.0	DW	09.1989→ MT " USA	
2.5 TD 88 kW (120 PS) 1T	01.1990→12.1990	7.21239.50.0	EUV		
2.5 TDI 85 kW (115 PS) ABP	06.1991→07.1992	7.21239.50.0	EUV		
2.6 V6 102-110 kW (139-150 PS) ABC, ACZ	03.1992→07.1994	4.07501.52.0	LLR	SPI	
2.8 V6 128 kW (174 PS) AAH	12.1990→07.1994	7.21483.54.0 7.21704.50.0	DW EUV	01.1993→	
<b>100 QUATTRO</b>					<b>26</b>
1.8 66 kW (90 PS) 4B	01.1988→12.1990	7.21704.50.0	EUV	FZG 44 J 200 100→	
2.2 E Turbo 121 kW (165 PS) MC	08.1986→11.1990	7.21239.50.0	EUV		
2.6 110 kW (150 PS) ABC	03.1992→07.1994	4.07501.52.0	LLR	SPI	
2.8 E 128 kW (174 PS) AAH	12.1990→06.1994	7.21483.54.0 7.21704.50.0	DW EUV	01.1993→	
<b>200</b>					<b>27</b>
2.2 Turbo 121-147 kW (165-200 PS) MC, 1B, 2B	01.1985→11.1990	7.21239.50.0	EUV	MOT 1B: 01.1988→	
<b>200 QUATTRO</b>					<b>28</b>
2.2 Turbo 121-147 kW (165-200 PS) MC, 1B	01.1985→11.1990	7.21239.50.0	EUV		

**316 - M3 (E36)**
**1**
**B**

<b>316i 1.6 (E36)</b> 73-75 kW (100-102 PS) M 40 B 16	12.1990→02.1994	<b>7.21911.83.0</b> <b>7.22341.08.0</b>	EUV EUV	
<b>316i g 1.6 (E36)</b> 75 kW (102 PS) M 43 B 16 Gas	11.1995→09.2000	<b>7.21911.83.0</b> <b>7.22341.08.0</b>	EUV EUV	
<b>318i 1.8 (E36)</b> 83-85 kW (113-115 PS) 18 4 E1	12.1990→02.1994	<b>7.21911.83.0</b> <b>7.22341.08.0</b>	EUV EUV	
<b>318i 1.8 (E36)</b> 85 kW (115 PS) M 43 B 18 Gas	09.1993→12.1999	<b>7.21911.83.0</b> <b>7.22341.08.0</b>	EUV EUV	
<b>318i 1.8 16V (E36)</b> 100-103 kW (136-140 PS) M 42 B 18	09.1992→12.1996	<b>7.21911.83.0</b> <b>7.22341.08.0</b>	EUV EUV	
<b>318i 1.9 16V (E36)</b> 103 kW (140 PS) M 44 B 19	03.1995→09.2000	<b>7.21911.83.0</b> <b>7.22341.08.0</b>	EUV EUV	
<b>318 tds 1.7 (E36)</b> 66 kW (90 PS) M 41 D 18	09.1994→09.2000	<b>7.21911.83.0</b> <b>7.22341.08.0</b>	EUV EUV	
<b>320i 24V (E36)</b> 110 kW (150 PS) M 50 B 20, M 50 B 20 M, M 52 B 20	09.1990→12.1999	<b>7.22341.08.0</b>	EUV	
<b>323i 24V (E36)</b> 125 kW (170 PS) M 52 B 25 125 kW	09.1994→09.2000	<b>7.22341.08.0</b>	EUV	
<b>325i 24V (E36)</b> 141 kW (192 PS) M 50 B 25 M	09.1990→08.1992	<b>7.22341.08.0</b>	EUV	
<b>325 td (E36)</b> 85 kW (115 PS) M 51 D 25 WA 85 kW	09.1991→12.1999	<b>7.21903.73.0</b> <b>7.21911.83.0</b> <b>7.22341.08.0</b>	DW EUV EUV	
<b>325 tds (E36)</b> 105 kW (143 PS) M 51 D 25 WA 105 kW	05.1993→12.1999	<b>7.21903.73.0</b> <b>7.21911.83.0</b> <b>7.22341.08.0</b>	DW EUV EUV	

**316 - M3 (E46)**
**2**

<b>318i 1.9 (E46)</b> 87 kW (118 PS) M 43 B 19	04.1998→09.2001	<b>7.21911.83.0</b> <b>7.22341.08.0</b>	EUV EUV	
<b>320i 24V (E46)</b> 110 kW (150 PS) M 52 B 20	04.1998→	<b>7.22341.08.0</b>	EUV	
<b>320i 2.0 24V (E46)</b> 110 kW (150 PS) M 52 B 20	04.1998→09.2001	<b>7.22341.08.0</b>	EUV	
<b>320 d Turbo 16V (E46)</b> 95-100 kW (130-136 PS) M 47 D 20 95 kW	04.1998→09.2001	<b>7.22341.08.0</b> <b>7.22796.01.0</b>	EUV DW	
<b>328i 24V (E46)</b> 142 kW (193 PS) M 52 B 28	04.1998→09.2000	<b>7.22341.08.0</b>	EUV	
<b>330 d Turbo 24V (E46)</b> 135-142 kW (184-193 PS) M 57 D 30	10.1999→	<b>7.22341.08.0</b> <b>7.22796.01.0</b>	EUV DW	

**320 - M 535 (E12)**
**3**

<b>520 (E12)</b> 85 kW (115 PS) M 10 B 20 85 kW	05.1971→08.1977	<b>7.12977.51.0</b>	UAV	10.1975→
--	-----------------	---------------------	-----	----------

**518 - M5 (E34)**
**4**

<b>518i (E34)</b> 83-85 kW (113-115 PS) 18 4 E1	09.1989→04.1994	<b>7.21911.83.0</b>	EUV	
<b>518i g (E34)</b> 83-85 kW (113-115 PS) 18 4 E1	04.1993→04.1994	<b>7.21911.83.0</b>	EUV	
<b>518i g (E34)</b> 85 kW (115 PS) M 43 B 18 Gas	04.1993→12.1996	<b>7.21911.83.0</b>	EUV	
<b>524 td (E34)</b> 85 kW (115 PS) M 21 D 24 WA	03.1988→12.1991	<b>7.21911.83.0</b>	EUV	
<b>525 td (E34)</b> 85 kW (115 PS) M 51 D 25 WA 85 kW	09.1991→12.1996	<b>7.21903.73.0</b> <b>7.21911.83.0</b>	DW EUV	



B

**518 - M5 (E34)**

**4**

<b>525 tds (E34)</b> 105 kW (143 PS) M 51 D 25 WA 105 kW	09.1991→12.1996	<b>7.21903.73.0</b>	DW	
		<b>7.21911.83.0</b>	EUV	
<b>530i V8 (E34)</b> 160 kW (218 PS) M 60 B 30	09.1992→12.1996	<b>7.22340.63.0</b>	EUV	
<b>540i V8 32V (E34)</b> 210 kW (286 PS) M 60 B 40	09.1992→12.1996	<b>7.22340.63.0</b>	EUV	
<b>M5 3.8i 24V (E34)</b> 240-250 kW (326-340 PS) S 38 B 38	03.1992→12.1995	<b>7.22340.63.0</b>	EUV	

**515 - M5 (E39)**

**5**

<b>520i 2.0 24V (E39)</b> 110 kW (150 PS) M 52 B 20	09.1995→09.2000	<b>7.22341.08.0</b>	EUV	
<b>520 D Turbo 16V (E39)</b> 95-100 kW (130-136 PS) M 47 D 20 95 kW	04.2000→	<b>7.22341.08.0</b>	EUV	
		<b>7.22796.01.0</b>	DW	
<b>523i 24V (E39)</b> 125 kW (170 PS) M 52 B 25 125 kW	09.1995→09.2000	<b>7.22341.08.0</b>	EUV	
<b>525 td (E39)</b> 85 kW (115 PS) M 51 D 25 WA 85 kW	01.1996→09.2000	<b>7.21903.73.0</b>	DW	
		<b>7.22341.08.0</b>	EUV	
		<b>7.22796.01.0</b>	DW	
<b>525 tds (E39)</b> 105 kW (143 PS) M 51 D 25 WA 105 kW	01.1996→09.2000	<b>7.21903.73.0</b>	DW	
		<b>7.22341.08.0</b>	EUV	
		<b>7.22796.01.0</b>	DW	
<b>530 d Turbo 24V (E39)</b> 135-142 kW (184-193 PS) M 57 D 30	08.1998→	<b>7.22341.08.0</b>	EUV	
		<b>7.22796.01.0</b>	DW	
<b>535i V8 32V (E39)</b> 173-180 kW (235-245 PS) M 62 B 35	01.1996→	<b>7.22340.63.0</b>	EUV	
<b>540i V8 32V (E39)</b> 210 kW (286 PS) M 62 B 44	01.1996→	<b>7.22340.63.0</b>	EUV	
		<b>7.22341.08.0</b>	EUV	
<b>M5 5.0i 32V (E39)</b> 294 kW (400 PS) 50 8 S1	10.1998→	<b>7.22340.63.0</b>	EUV	

**725 - 750 (E38)**

**6**

<b>725 tds (E38)</b> 105 kW (143 PS) M 51 D 25 WA 105 kW	01.1996→12.2000	<b>7.21903.73.0</b>	DW	
		<b>7.22341.08.0</b>	EUV	
		<b>7.22796.01.0</b>	DW	
<b>730i V8 (E38)</b> 160 kW (218 PS) M 60 B 30	06.1994→03.1997	<b>7.22340.63.0</b>	EUV	
<b>730 d Turbo 24V (E38)</b> 135-142 kW (184-193 PS) M 57 D 30	09.1995→12.2001	<b>7.22341.08.0</b>	EUV	
		<b>7.22796.01.0</b>	DW	
<b>735i V8 32V (E38)</b> 173-180 kW (235-245 PS) M 62 B 35	09.1994→12.2001	<b>7.22340.63.0</b>	EUV	
<b>740i V8 32V (E38)</b> 210 kW (286 PS) M 60 B 40, M 62 B 44	06.1994→12.2001	<b>7.22340.63.0</b>	EUV	
<b>740 d 32V (E38)</b> 180 kW (245 PS) 39 8 D1	10.1998→02.2001	<b>7.22341.08.0</b>	EUV	
		<b>7.22796.01.0</b>	DW	
<b>750i V12 (E38)</b> 240 kW (326 PS) M 73 B 54	06.1994→12.2001	<b>7.22341.08.0</b>	EUV	

**840 - 850 (E31)**

**7**

<b>830 Ci (E31)</b> 160 kW (218 PS) M 60 B 30	08.1992→12.1999	<b>7.22341.08.0</b>	EUV	
<b>840 Ci V8 32V (E31)</b> 210 kW (286 PS) M 60 B 40, M 62 B 44	04.1993→12.1999	<b>7.22341.08.0</b>	EUV	



**840 - 850 (E31) 7**

<b>850 Ci 5.0 V12 (E31)</b> 220 kW (300 PS) M 70 B 50	07.1989→12.1994	<b>7.22341.08.0</b>	EUV	
<b>850 Ci 5.4 (E31)</b> 240 kW (326 PS) M 73 B 54	03.1994→12.1999	<b>7.22341.08.0</b>	EUV	
<b>850 CSi 5.6 V12 (E31)</b> 280 kW (380 PS) M 70 B 56	08.1992→10.1996	<b>7.22341.08.0</b>	EUV	

**X5 (E53) 8**

<b>X5 4.4i 32V (E53)</b> 210 kW (286 PS) M 62 B 44	10.1998→06.2000	<b>7.22340.63.0</b>	EUV	
---	-----------------	---------------------	-----	--

**Z 3 (E36/7) 9**

<b>Z 3 1.9i (E36/7)</b> 87 kW (118 PS) M 43 B 19	09.1998→	<b>7.22341.08.0</b>	EUV	
<b>Z 3 1.9i 16V (E36/7)</b> 103 kW (140 PS) M 44 B 19	09.1995→12.1999	<b>7.22341.08.0</b>	EUV	
<b>Z 3 2.0i 24V (E36/7)</b> 110 kW (150 PS) M 52 B 20	04.1999→12.2000	<b>7.22341.08.0</b>	EUV	
<b>Z 3 2.8i 24V (E36/7)</b> 142 kW (193 PS) M 52 B 28	11.1996→09.2000	<b>7.22341.08.0</b>	EUV	

**Z 8 (E52) 10**

294 kW (400 PS) 50 8 S1	03.2000→	<b>7.22341.08.0</b>	EUV	
----------------------------	----------	---------------------	-----	--

--	--	--	--	--



## C3 1

<b>C</b>	1.4 HDi 50 kW (68 PS) DV 4 TD	07.2001→	7.28328.05.0	DW	
	1.4 HDi 16V 66 kW (90 PS) DV 4 TED 4	07.2001→	7.28328.05.0	DW	

## C5 2

2.0 HDi 80-81 kW (109-110 PS) RHZ	03.2001→	7.28328.05.0	DW	
--------------------------------------	----------	--------------	----	--

## EVASION 3

2.0 HDi 80-81 kW (109-110 PS) RHZ	01.1999→	7.28328.05.0	DW	
--------------------------------------	----------	--------------	----	--

## XSARA 4

2.0 HDi 80-81 kW (109-110 PS) RHZ	09.2000→	7.28328.05.0	DW	
--------------------------------------	----------	--------------	----	--

## XSARA PICASSO 5

2.0 HDi 66 kW (90 PS) RHY	12.1999→	7.28328.05.0	DW	
------------------------------	----------	--------------	----	--



<b>CHAIRMAN</b>					<b>1</b>
3.2i 24V 162 kW (220 PS) M 104.992	10.1997→	7.21071.50.0	EUV		
<b>KORANDO</b>					<b>2</b>
3.2i 24V 155-170 kW (211-231 PS) M 104.992, M 104.995, M 104.996	07.1996→	7.21071.50.0	EUV		
<b>MUSSO</b>					<b>3</b>
3.2i 24V 162 kW (220 PS) M 104.992	01.1996→	7.21071.50.0	EUV		
<b>REXTON</b>					<b>4</b>
RX 320 162 kW (220 PS) M 104.992	09.2002→	7.21071.50.0	EUV		

**D**



**DOBLÒ**

**1**

<b>1.2 i.e.</b> 48 kW (65 PS) 223 A5.000	07.2000→	<b>7.28148.01.0</b>	EUV	
<b>1.2 i.e. 16V</b> 59-63 kW (80-86 PS) 176 B9.000		<b>7.28148.01.0</b>	EUV	
<b>1.6 i.e. 16V</b> 76 kW (103 PS) 182 A4.000, 182 B6.000	03.2001→	<b>7.28148.01.0</b>	EUV	
<b>1.9 D</b> 46-48 kW (63-65 PS) 223 A6.000	07.2000→02.2001	<b>7.28148.01.0</b>	EUV	
<b>1.9 JTD</b> 74-77 kW (101-105 PS) 182 B4.000, 182 B9.000	01.2001→	<b>7.28148.01.0</b>	EUV	

**PALIO**

**2**

<b>1.2 i.e.</b> 44-55 kW (60-75 PS) 176 A8.000, 178 B5.000	09.1997→	<b>7.28148.01.0</b>	EUV	
<b>1.2 i.e. 16V</b> 54-63 kW (73-86 PS) 188 A4.000, 188 A5.000	09.1997→	<b>7.28148.01.0</b>	EUV	
<b>1.4 i.e.</b> 51 kW (69 PS) 178 B2.000, 178 B2.016	11.1997→	<b>7.28148.01.0</b>	EUV	
<b>1.6 i.e.</b> 69 kW (94 PS) 178 C8.098	06.2001→	<b>7.28148.01.0</b>	EUV	
<b>1.6 i.e. 16V</b> 74-78 kW (100-106 PS) M645 KA.15.C, 176 B.000, 178 B3.000, 182 B6.000	09.1996→	<b>7.28148.01.0</b>	EUV	
<b>1.7 TD</b> 46-53 kW (63-72 PS) 176 A3.000, 176 B7.000	09.1997→	<b>7.28148.01.0</b>	EUV	
<b>1.9 D</b> 46-48 kW (63-65 PS) 223 A6.000	11.2000→	<b>7.28148.01.0</b>	EUV	
<b>1.9 JTD</b> 74 kW (101 PS) 182 B9.000	01.2001→	<b>7.28148.01.0</b>	EUV	

**PUNTO**

**3**

<b>1.1 i.e.</b> 40 kW (54 PS) 176 A6.000, 176 B2.000	08.1993→08.1999	<b>7.28148.01.0</b>	EUV	
<b>1.2</b> 46 kW (62 PS) M609 CA.1.2C	09.1993→06.1996	<b>7.28148.01.0</b>	EUV	
<b>1.2 i.e.</b> 43-63 kW (58-86 PS) 176 A7.000, 176 A8.000, 176 B1.000, 176 B4.000, 188 A4.000, 188 A5.000	08.1993→	<b>7.28148.01.0</b>	EUV	
<b>1.2 i.e. 16V</b> 59-63 kW (80-86 PS) M657 BA.12.T, 176 B9.000, 188 A5.000	04.1997→	<b>7.28148.01.0</b>	EUV	
<b>1.4 i.e. Turbo</b> 82-98 kW (111-133 PS) 146 A8.000	09.1993→08.1996	<b>7.28148.01.0</b>	EUV	
<b>1.4 i.e. Turbo</b> 96-98 kW (131-133 PS) 176 A4.000	08.1993→08.1999	<b>7.20733.51.0</b> <b>7.28148.01.0</b>	UAV EUV	
<b>1.4 i.e. Turbo</b> 98 kW (133 PS) 176 B6.000	03.1996→08.1999	<b>7.21493.50.0</b> <b>7.28148.01.0</b>	EUV EUV	
<b>1.6 i.e.</b> 57-65 kW (78-88 PS) M202 PB.15.0, 176 A9.000	09.1993→04.1997	<b>7.28148.01.0</b>	EUV	
<b>1.7 D</b> 42 kW (57 PS) 176 B3.000	05.1997→08.1999	<b>7.28148.01.0</b>	EUV	
<b>1.7 TD</b> 46-53 kW (63-72 PS) M708 HAT.17, M708 UT.17.L014, 176 A3.000, 176 A5.000, 176 B7.000	08.1993→	<b>7.28148.01.0</b>	EUV	
<b>1.8 i.e. 16V</b> 96 kW (131 PS) 183 A1.000, 188 A6.000	05.1999→	<b>7.28148.01.0</b>	EUV	
<b>1.9 JTD</b> 59-85 kW (80-116 PS) 182 B4.000, 188 A2.000, 188 A7.000	05.1999→	<b>7.28148.01.0</b>	EUV	

F

**STILO**
**4**

<b>1.2 i.e. 16V</b> 59-63 kW (80-86 PS) 188 A5.000	10.2001→	<b>7.28148.01.0</b>	EUV
<b>1.6 i.e. 16V</b> 76 kW (103 PS) 182 B6.000	10.2001→	<b>7.28148.01.0</b>	EUV
<b>1.8 i.e. 16V</b> 96-98 kW (131-133 PS) 192 A4.000	10.2001→	<b>7.28148.01.0</b>	EUV
<b>1.9 JTD</b> 59-85 kW (80-115 PS) 192 A1.000, 192 A3.000	10.2001→	<b>7.28148.01.0</b>	EUV
<b>2.4 i.e. 20V</b> 125 kW (170 PS) 192 A2.000	10.2001→	<b>7.28148.01.0</b>	EUV

**F**
**STRADA (USA)**
**5**

<b>Strada 1.1</b> 40-41 kW (54-55 PS) 138 B.000, 138 C1.000	02.1983→12.1987	<b>7.28148.01.0</b>	EUV
<b>Strada 1.2 i.e.</b> 44-54 kW (60-73 PS) 178 B5.000, 188 A4.000	03.1999→	<b>7.28148.01.0</b>	EUV
<b>Strada 1.7 D</b> 40-44 kW (55-60 PS) 138 A6.000, 138 B6.000, 149 B3.000	03.1980→12.1987	<b>7.28148.01.0</b>	EUV
<b>Strada 1.7 TD</b> 51-53 kW (69-72 PS) 176 A3.000	03.1999→	<b>7.28148.01.0</b>	EUV
<b>Strada 1.9 D</b> 46-48 kW (63-65 PS) 223 A6.000	11.2000→	<b>7.28148.01.0</b>	EUV



## GALAXY

1

<b>1.9 TDI</b> 66 kW (90 PS) AHU, ANU	05.1995→	<b>7.21895.55.0</b>	EUV	
		<b>7.21903.70.0</b>	DW	
<b>1.9 TDI</b> 81 kW (110 PS) AFN	10.1996→03.2000	<b>7.21903.70.0</b>	DW	
		<b>7.21903.75.0</b>	DW	
<b>1.9 TDI</b> 85 kW (115 PS) AUY	04.2000→	<b>7.21903.70.0</b>	DW	

F



**LYBRA**

**1**

2.4 JTD 103 kW (140 PS)  
839 A6.000

09.2000→

**7.21903.48.0** DW

**L**



## C-Klasse

**1**

<b>C 240 (202)</b> 120-130 kW (163-177 PS) M 112.910, M 112.915	06.1997→02.2001	<b>7.22355.01.0</b>	EUV
<b>C 240 2.6 (203)</b> 130 kW (177 PS) M 112.912	05.2000→	<b>7.22355.01.0</b>	EUV
<b>C 240 (203)</b> M 112.916		<b>7.22355.01.0</b>	EUV
<b>C 280 (202)</b> 142-145 kW (193-197 PS) M 104.941, M 112.920	05.1993→02.2001	<b>7.21071.50.0</b> <b>7.22355.01.0</b>	EUV EUV
<b>C 280 (203)</b> 145 kW (197 PS) M 112.924	05.2000→	<b>7.22355.01.0</b>	EUV
<b>C 320 (203)</b> 160 kW (218 PS) M 112.946, M 112.953	05.2000→	<b>7.22355.01.0</b>	EUV
<b>C 32 Kompressor AMG (203)</b>	02.2001→	<b>7.22355.01.0</b>	EUV
<b>C 43 AMG (202)</b> 225 kW (306 PS) M 113.944 AMG	10.1997→04.2000	<b>7.22355.01.0</b>	EUV

## CL-Klasse

**2**

<b>CL 500 (215)</b> 218-225 kW (296-306 PS) M 113.960	08.1999→07.2003	<b>7.22355.01.0</b>	EUV
<b>CL 55 AMG (215)</b> 265 kW (360 PS) M 113.986 AMG	09.1999→	<b>7.22355.01.0</b>	EUV

## CLK-Klasse

**3**

<b>CLK 240 2.6 (209 )</b> 130 kW (177 PS) M 112.912	03.2002→	<b>7.22355.01.0</b>	EUV
<b>CLK 320 (208)</b> 160 kW (218 PS) M 112.940	06.1997→06.2002	<b>7.22355.01.0</b>	EUV
<b>CLK 320 (209)</b> 160 kW (218 PS) M 112.955	05.2000→	<b>7.22355.01.0</b>	EUV
<b>CLK 430 (208)</b> 205 kW (279 PS) M 113.943	08.1998→	<b>7.22355.01.0</b>	EUV
<b>CLK 500 (209)</b> 225 kW (306 PS) M 113.968	03.2002→	<b>7.22355.01.0</b>	EUV
<b>CLK 55 AMG (208)</b> 255 kW (347 PS) M 113.984 AMG	05.1999→	<b>7.22355.01.0</b>	EUV
<b>CLK 55 AMG (209)</b> 265 kW (360 PS) M 113.987 AMG	08.2000→	<b>7.22355.01.0</b>	EUV

## E-Klasse

**4**

<b>E 200 D (124)</b> 53-55 kW (72-75 PS) OM 601.912	07.1993→06.1995	<b>7.21071.50.0</b>	EUV
<b>E 240 (210)</b> 120-125 kW (163-170 PS) M 112.911	09.1997→	<b>7.22355.01.0</b>	EUV
<b>E 240 (211)</b> 125-130 kW (170-177 PS) M 112.912, M 112.913	02.1997→	<b>7.22355.01.0</b>	EUV
<b>E 240.2.6 (210)</b> 125 kW (170 PS) M 112.914	06.1999→	<b>7.22355.01.0</b>	EUV
<b>E 240 2.6 (211)</b> 125 kW (170 PS) M 112.914	09.2000→	<b>7.22355.01.0</b>	EUV
<b>E 280 (124)</b> 142 kW (193 PS) M 104.942	07.1993→05.1996	<b>7.21071.50.0</b>	EUV
<b>E 280 (210)</b> 142-150 kW (193-204 PS) M 104.942, M 104.945, M 112.921	06.1995→	<b>7.21071.50.0</b> <b>7.22355.01.0</b>	EUV EUV
<b>E 280 (211)</b> 150 kW (204 PS) M 112.926		<b>7.22355.01.0</b>	EUV
<b>E 320 (124)</b> 162 kW (220 PS) M 104.992	09.1992→06.1998	<b>7.21071.50.0</b>	EUV
<b>E 320 (210)</b> 165-170 kW (224-231 PS) M 104.995, M 112.941	06.1995→06.1999	<b>7.21071.50.0</b> <b>7.22355.01.0</b>	EUV EUV

**M**



<b>E-Klasse</b>					<b>4</b>
<b>E 420 (124)</b> 205 kW (280 PS) M 119.975	07.1993→06.1995	<b>7.21071.50.0</b>	EUV		
<b>E 420 (210)</b> 205 kW (280 PS) M 119.975, M 119.985	01.1996→08.1997	<b>7.21071.50.0</b>	EUV		
<b>E 430 (210)</b> 205 kW (279 PS) M 113.940	06.1997→	<b>7.22355.01.0</b>	EUV		
<b>E 500 (211)</b> 225 kW (306 PS) M 113.967	03.2002→	<b>7.22355.01.0</b>	EUV		
<b>E 55 AMG (210)</b> 255-265 kW (347-360 PS) M 113.980 AMG	09.1997→	<b>7.22355.01.0</b>	EUV		
<b>E 55 AMG (220)</b> 255-265 kW (347-360 PS) M 113.980 AMG	04.1999→	<b>7.22355.01.0</b>	EUV		
<b>G-Klasse</b>					<b>5</b>
<b>G 320 (463)</b> 155-158 kW (211-215 PS) M 104.996, M 112.945	08.1993→	<b>7.21071.50.0</b> <b>7.22355.01.0</b>	EUV EUV		
<b>G 320 (460)</b> 170 kW (231 PS) M 104.995	09.1994→	<b>7.21071.50.0</b>	EUV		
<b>G 500 (463)</b> 170-225 kW (231-306 PS) M 113.962, M 117.965	08.1993→	<b>7.22355.01.0</b>	EUV		
<b>ML-Klasse</b>					<b>6</b>
<b>ML 320 (163)</b> 160 kW (218 PS) M 112.942	09.1997→	<b>7.22355.01.0</b>	EUV		
<b>ML 430 (163)</b> 200 kW (272 PS) M 113.942	06.1998→	<b>7.22355.01.0</b>	EUV		
<b>ML 500 (163)</b> 215 kW (292 PS) M 113.965	09.2001→	<b>7.22355.01.0</b>	EUV		
<b>ML 55 AMG (163)</b> 255 kW (347 PS) M 113.981 AMG	11.1999→	<b>7.22355.01.0</b>	EUV		
<b>S-Klasse</b>					<b>7</b>
<b>S 280 (140)</b> 142-145 kW (193-197 PS) M 104.944	06.1993→09.1998	<b>7.21071.50.0</b>	EUV		
<b>S 280 (220)</b> 150 kW (204 PS) M 112.922	10.1998→	<b>7.22355.01.0</b>	EUV		
<b>S 320 (140)</b> 170 kW (231 PS) M 104.990, M 104.994	03.1993→09.1998	<b>7.21071.50.0</b>	EUV		
<b>S 320 (220)</b> 165-170 kW (224-231 PS) M 112.944	10.1998→	<b>7.22355.01.0</b>	EUV		
<b>S 350 3.7 (220)</b> 180 kW (245 PS) M 112.972, M 112.975	09.2002→	<b>7.22355.01.0</b>	EUV		
<b>S 350 D Turbo (140)</b> 110 kW (149 PS) OM 603.971	06.1993→06.1996	<b>7.21071.50.0</b>	EUV		
<b>S 370 (220)</b> 180 kW (245 PS) M 112.972	09.2002→	<b>7.22355.01.0</b>	EUV		
<b>S 420 (140)</b> 205-210 kW (279-286 PS) M 119.971, M 119.981	06.1993→08.1999	<b>7.21071.50.0</b>	EUV		
<b>S 430 (220)</b> 205 kW (279 PS) M 113.941, M 113.948	09.1997→	<b>7.22355.01.0</b>	EUV		
<b>S 500 (140)</b> 235-240 kW (320-326 PS) M 119.970, M 119.980	06.1993→09.1996	<b>7.21071.50.0</b>	EUV		
<b>S 500 (220)</b> 218-225 kW (296-306 PS) M 113.960	10.1998→	<b>7.22355.01.0</b>	EUV		
<b>S 55 AMG (220)</b> 265 kW (360 PS) M 113.986 AMG	08.2000→	<b>7.22355.01.0</b>	EUV		

**M**



SL-Klasse					8
<b>SL 280 (129)</b> 142-150 kW (193-204 PS) M 104.943, M 112.923	07.1993→08.2001	<b>7.21071.50.0</b>	EUV		
		<b>7.22355.01.0</b>	EUV		
<b>SL 280 (230)</b> 150 kW (204 PS) M 112.925		<b>7.22355.01.0</b>	EUV		
<b>SL 320 (129)</b> 165-170 kW (224-231 PS) M 104.991, M 112.943	07.1993→08.2001	<b>7.21071.50.0</b>	EUV		
		<b>7.22355.01.0</b>	EUV		
<b>SL 320 (230)</b> 158 kW (215 PS) M 112.948		<b>7.22355.01.0</b>	EUV		
<b>SL 350 3.7 (230)</b> 180 kW (245 PS) M 112.973	09.2002→	<b>7.22355.01.0</b>	EUV		
<b>SL 500 (129)</b> 218-235 kW (296-320 PS) M 113.961, M 119.982	07.1993→	<b>7.21071.50.0</b>	EUV		
		<b>7.22355.01.0</b>	EUV		
<b>SL 500 (230)</b> 218-225 kW (209-306 PS) M 113.963	10.2001→	<b>7.22355.01.0</b>	EUV		
SLK-Klasse					9
<b>SLK 320 AMG (170)</b> 260 kW (354 PS) M 112.960	06.1999→	<b>7.22355.01.0</b>	EUV		
SPRINTER					10
<b>Sprinter 212 D 2.9</b> 90 kW (122 PS) OM 602.980	02.1995→03.2000	<b>7.21071.50.0</b>	EUV		
<b>Sprinter 312 D 2.9</b> 90 kW (122 PS) OM 602.980	02.1995→03.2000	<b>7.21071.50.0</b>	EUV		
<b>Sprinter 410 D 2.9</b> 90 kW (122 PS) OM 602.980, OM 602.986	02.1995→03.2000	<b>7.21071.50.0</b>	EUV		
<b>Sprinter 412 D 2.9</b> 90 kW (122 PS) OM 602.980	02.1995→03.2000	<b>7.21071.50.0</b>	EUV		
VARIO					11
<b>Vario 512 D 2.9</b> 90 kW (122 PS) OM 602.984	09.1996→	<b>7.21071.50.0</b>	EUV		
<b>Vario 612 D 2.9</b> 90 kW (122 PS) OM 602.984, OM 602.985	09.1996→	<b>7.21071.50.0</b>	EUV		
<b>Vario 812 D 2.9</b> 90 kW (122 PS) OM 602.984, OM 602.985	09.1996→	<b>7.21071.50.0</b>	EUV		
<b>Vario 814 D 2.9</b> 90 kW (122 PS) OM 602.984, OM 602.985	09.1996→	<b>7.21071.50.0</b>	EUV		
190					12
<b>190 D 2.5 (201)</b> 69 kW (94 PS) OM 602.911	04.1985→08.1993	<b>7.21071.50.0</b>	EUV		
<b>190 2.0 (201)</b> 63-72 kW (86-98 PS) M 102.921, M 102.924, M 102.938	10.1982→05.1990	<b>7.20733.51.0</b>	UAV		
200					13
<b>200 D (124)</b> 53-55 kW (72-75 PS) OM 601.912	12.1984→06.1993	<b>7.21071.50.0</b>	EUV		
<b>200 (123)</b> 62-80 kW (84-109 PS) M 102.920, M 102.939, M 115.938, M 115.939	02.1976→11.1985	<b>7.20229.50.0</b>	UAV		
		<b>7.20733.51.0</b>	UAV		
<b>200 (124)</b> 72 kW (98 PS) M 102.922	01.1985→06.1993	<b>7.20733.51.0</b>	UAV		
230					14
<b>230 G (460)</b> 66 kW (90 PS) M 115.973	03.1979→03.1982	<b>7.20229.50.0</b>	UAV		
		<b>7.21071.50.0</b>	EUV		
<b>230 (123)</b> 80 kW (109 PS) M 115.954	02.1976→03.1981	<b>7.20229.50.0</b>	UAV		
<b>230.4 (115)</b> 81 kW (110 PS) M 115.951	08.1973→12.1976	<b>7.21071.50.0</b>	EUV		

M



<b>250</b>					<b>15</b>
<b>250 D (124)</b> 69 kW (94 PS) OM 602.911, OM 602.912	04.1985→06.1993	<b>7.21071.50.0</b>	EUV		
<b>250 (123)</b> 95-103 kW (129-140 PS) M 123.920, M 123.921	02.1976→07.1985	<b>7.20524.50.0</b>	UAV		
<b>280</b>					<b>16</b>
<b>280 E (124)</b> 142 kW (193 PS) M 104.942	09.1992→06.1993	<b>7.21071.50.0</b>	EUV		
<b>280 S (116)</b> 105-115 kW (143-156 PS) M 110.922, M 110.932	08.1972→12.1984	<b>7.20524.50.0</b>	UAV		
<b>280 S (126)</b> 115 kW (156 PS) M 110.924, M 110.926	12.1979→07.1985	<b>7.20524.50.0</b>	UAV		
<b>280 (114)</b> 107-118 kW (145-160 PS) M 110.921, M 110.931	06.1972→12.1984	<b>7.20524.50.0</b> <b>7.21071.50.0</b>	UAV EUV		
<b>280 (123)</b> 115 kW (156 PS) M 110.923	02.1976→08.1981	<b>7.20524.50.0</b>	UAV		
<b>300</b>					<b>17</b>
<b>300 E 3.2 (124)</b> 162 kW (220 PS) M 104.992	09.1992→06.1993	<b>7.21071.50.0</b>	EUV		
<b>300 SD 3.5 Turbo (140)</b> 110 kW (149 PS) OM 603.971	07.1991→05.1993	<b>7.21071.50.0</b>	EUV		
<b>300 SE 2.8 (124)</b> 142 kW (193 PS) M 104.942	01.1993→06.1993	<b>7.21071.50.0</b>	EUV		
<b>300 SE 2.8 (126)</b> 142 kW (193 PS) M 104.942	01.1993→06.1993	<b>7.21071.50.0</b>	EUV		
<b>300 SE 2.8 (140)</b> 142-145 kW (193-197 PS) M 104.944	09.1992→05.1993	<b>7.21071.50.0</b>	EUV		
<b>320</b>					<b>18</b>
<b>320 E (124)</b> 162 kW (220 PS) M 104.992	09.1992→06.1993	<b>7.21071.50.0</b>	EUV		
<b>400</b>					<b>19</b>
<b>400 E 4.2 (124)</b> 205 kW (280 PS) M 119.975	10.1992→06.1993	<b>7.21071.50.0</b>	EUV		
<b>400 SE 4.2 (140)</b> 205-210 kW (280-286 PS) M 119.971	02.1991→05.1993	<b>7.21071.50.0</b>	EUV		
<b>450</b>					<b>20</b>
<b>450 SE (116)</b> 140-165 kW (190-224 PS) M 117.983, M 117.986, M 117.993	01.1973→09.1980	<b>7.21071.50.0</b>	EUV		
<b>450 SL (107)</b> 140-160 kW (190-218 PS) M 117.982, M 117.985, M 117.992	10.1972→10.1980	<b>7.21071.50.0</b>	EUV		
<b>500</b>					<b>21</b>
<b>500 SL (129)</b> 235-245 kW (320-333 PS) M 119.960, M 119.972	03.1989→09.1985	<b>7.21071.50.0</b>	EUV		
<b>2t-Serie</b>					<b>22</b>
<b>Series 208 2.3</b> 62-77 kW (84-105 PS) M 102.942, M 102.945, M 115.955, M 115.972	05.1977→06.1995	<b>7.20524.50.0</b>	UAV		
<b>Series 210 2.3</b> 62-77 kW (84-105 PS) M 102.942, M 102.945, M 115.955, M 115.972	05.1977→06.1995	<b>7.20524.50.0</b>	UAV		

**M**



## 3t-Serie

23

<b>Series 308 2.3</b> 62-77 kW (84-105 PS) M 102.942, M 102.945, M 115.972	05.1977→06.1995	<b>7.20524.50.0</b>	UAV
<b>Series 310 2.3</b> 62-77 kW (84-105 PS) M 102.942, M 102.945, M 115.972	05.1977→06.1995	<b>7.20524.50.0</b>	UAV

M



ASTRA F						1
1.4i 44 kW (60 PS) C 14 NZ	09.1991→01.1999	4.07501.50.0	LLR	SPI		
1.4i 16V 66 kW (90 PS) X 14 XE	01.1996→09.1998	7.22449.02.0	EUV			
1.6i 52-55 kW (71-75 PS) C 16 NZ, X 16 SZ, X 16 SZR	08.1991→09.1998	4.07501.50.0	LLR	SPI		
1.6i Eco 52 kW (71 PS) X 16 SZ	03.1993→08.1996	4.07501.50.0	LLR	SPI		
1.7 TD 60 kW (82 PS) X 17 DT TC4EE1	12.1991→09.1998	7.22138.50.0	EUV			
1.8i 66 kW (90 PS) C 18 NZ	01.1991→09.1998	4.07501.50.0	LLR	SPI		
1.8i 16V 85 kW (116 PS) C 18 XEL, X 18 XE	07.1994→09.1998	7.22293.03.0	EUV			
		7.22293.50.0	EUV		09.1995→	
2.0i 16V 100 kW (136 PS) X 20 XEV	02.1995→09.1998	7.22293.03.0	EUV			
		7.22293.50.0	EUV		09.1995→	
ASTRA G						2
1.6 55 kW (75 PS) X 16 SZR	02.1998→09.2000	4.07501.50.0	LLR	SPI		
1.7 DTI 16V Eco4 55 kW (75 PS) Y 17 DT	02.2000→	7.21903.10.0	DW			
		7.21903.12.0	DW			
1.8 16V 85-92 kW (116-125 PS) X 18 XE1, Z 18 XE	02.1998→	7.22449.02.0	EUV			
1.8i 16V 85 kW (115 PS) Z 18 XEL	01.2000→	7.22449.02.0	EUV			
2.0 16V 100 kW (136 PS) X 20 XEV	02.1998→	7.22566.50.0	EUV			
ASTRA G CABRIO						3
1.8 16V 92 kW (125 PS) Z 18 XE	03.2001→	7.22449.02.0	EUV			
ASTRA G COUPÉ						4
1.8 16V 85-92 kW (116-125 PS) X 18 XE1, Z 18 XE	03.2000→	7.22449.02.0	EUV			
CALIBRA						5
2.0i 16V 100 kW (136 PS) X 20 XEV	02.1994→07.1997	7.22293.03.0	EUV			
		7.22293.50.0	EUV		10.1995→	
		7.22566.50.0	EUV			
CORSA A						6
1.2 33 kW (45 PS) C 12 NZ	09.1989→03.1993	4.07501.51.0	LLR	SPI		
1.3 44 kW (60 PS) C 13 N	09.1986→09.1990	4.07501.51.0	LLR	SPI		
1.4 44 kW (60 PS) C 14 NZ	01.1990→03.1993	4.07501.51.0	LLR	SPI		
1.6 GSI 55 kW (75 PS) C 16 NZ	08.1988→09.1992	4.07501.50.0	LLR	SPI		
CORSA B						7
1.0 12V 40 kW (54 PS) X 10 XE	11.1996→09.2000	7.20975.66.0	EUV			
1.2 33 kW (45 PS) C 12 NZ, X 12 SZ	03.1993→09.2000	4.07501.51.0	LLR	SPI		
		7.20975.66.0	EUV		01.1996→	
1.2i 33 kW (45 PS) 12 NZ	03.1993→09.2000	7.20975.66.0	EUV		01.1996→	
1.2 16V 48 kW (65 PS) X 12 XE	03.1998→09.2000	7.20975.66.0	EUV			

0



**CORSA B**

**7**

1.4 16V 66 kW (90 PS) X 14 XE	09.1994→09.2000	7.20975.66.0	EUV	01.1996→
1.4i 44-60 kW (60-82 PS) C 14 NZ, C 14 SE, X 14 SZ	03.1993→09.2000	4.07501.50.0	LLR	<b>MOT</b> C 14 NZ : AT SPi <b>MOT</b> C 14 SE, X 14 SZ: SPi
		7.20975.66.0	EUV	01.1996→
1.5 D 37 kW (50 PS) 15 D 4EC1	03.1993→09.2000	7.20975.66.0	EUV	01.1996→
1.5 TD 49 kW (67 PS) X 15 DT 4EC1-T, 15 DT 4EC1-T	03.1993→09.2000	7.20975.66.0	EUV	01.1996→
1.6 16V 78 kW (106 PS) X 16 XE	09.1994→09.2000	7.20975.66.0	EUV	01.1996→
1.6 GSI 16V 80 kW (109 PS) C 16 XE	03.1993→09.2000	7.20975.66.0	EUV	01.1996→
1.7 D 44 kW (60 PS) X 17 D 4EE1	02.1996→09.2000	7.20975.66.0	EUV	

**CORSA C**

**8**

1.7 DTI 16V 55 kW (75 PS) Y 17 DT	09.2000→	7.21903.10.0	DW	
		7.21903.12.0	DW	

**KADETT E**

**9**

1.4 44 kW (60 PS) C 14 NZ	01.1990→07.1994	4.07501.51.0	LLR	SPi
1.6 55 kW (75 PS) C 16 LZ, C 16 NZ, E 16 NZ	09.1986→07.1994	4.07501.50.0	LLR	SPi
1.8 66 kW (90 PS) C 18 NZ	06.1985→08.1991	4.07501.50.0	LLR	SPi

**OMEGA A**

**10**

1.8 60-85 kW (82-115 PS) E 18 NVR, 18 NV, 18 SEH, 18 SV	09.1986→03.1994	7.20975.66.0	EUV	
2.0 73-90 kW (99-122 PS) C 20 NE, C 20 NEF, C 20 NEJ, 20 SE	09.1986→03.1994	7.20975.66.0	EUV	
2.3 D 54 kW (73 PS) 23 YD	09.1986→03.1994	7.20975.66.0	EUV	
2.3 TD 66-74 kW (90-100 PS) 23 DTR, 23 YDT	09.1986→03.1994	7.20975.66.0	EUV	
2.4 92 kW (125 PS) C 24 NE	09.1988→03.1994	7.20975.66.0	EUV	
2.6 110 kW (150 PS) C 26 NE	09.1990→03.1994	7.20975.66.0	EUV	
3.0 115-130 kW (156-177 PS) C 30 LE, C 30 NE, 30 NE	03.1987→03.1994	7.20975.66.0	EUV	
3.0 24V 147-150 kW (200-204 PS) C 30 SE, C 30 SEJ	09.1989→03.1994	7.20975.66.0	EUV	
3.0 24V Evolution 500 169 kW (230 PS) C 30 XEI	03.1991→07.1992	7.20975.66.0	EUV	
Omega Lotus 3.6i Turbo 24V 277 kW (377 PS) C 36 GET	08.1990→09.1992	7.20975.66.0	EUV	

**OMEGA B**

**11**

2.5 TD 96 kW (130-131 PS) X 25 DT, 25 DT	04.1994→	7.21903.73.0	DW	
2.5 DTI 24V 110 kW (150 PS) Y 25 DT	09.2001→	7.21903.73.0	DW	

**SENATOR B** **12**

<b>2.5</b> 103 kW (140 PS) 25 NE	09.1990→09.1993	<b>7.20975.66.0</b>	EUV	
<b>2.6</b> 110 kW (150 PS) C 26 NE	09.1990→09.1993	<b>7.20975.66.0</b>	EUV	
<b>3.0</b> 115-130 kW (156-177 PS) C 30 LE, C 30 NE, 30 NE	09.1987→09.1993	<b>7.20975.66.0</b>	EUV	
<b>3.0 24V</b> 150 kW (204 PS) C 30 SE	09.1989→09.1993	<b>7.20975.66.0</b>	EUV	

**VECTRA A** **13**

<b>1.6</b> 52-55 kW (71-75 PS) C 16 NZ, E 16 NZ, X 16 SZ	09.1988→11.1995	<b>4.07501.50.0</b> <b>7.20975.66.0</b>	LLR EUV	SPi
<b>1.6</b> 60 kW (82 PS) 16 SV	09.1988→05.1993	<b>7.20975.66.0</b>	EUV	
<b>1.7 D</b> 42-44 kW (57-60 PS) 17 D, 17 DR	09.1988→11.1995	<b>7.20975.66.0</b>	EUV	
<b>1.7 TD</b> 60 kW (82 PS) X 17 DT TC4EE1, 17 DT	03.1990→11.1995	<b>7.20975.66.0</b>	EUV	
<b>1.8</b> 65-66 kW (88-90 PS) E 18 NVR, 18 SV	09.1988→10.1990	<b>7.20975.66.0</b>	EUV	
<b>1.8</b> 66 kW (90 PS) C 18 NZ	03.1990→11.1995	<b>4.07501.50.0</b> <b>7.20975.66.0</b>	LLR EUV	SPi
<b>2.0</b> 74-95 kW (100-129 PS) C 20 NE, C 20 NEF, 20 NE, 20 SEH	04.1988→11.1995	<b>7.20975.66.0</b>	EUV	
<b>2.0i 16V</b> 100-110 kW (136-150 PS) C 20 XE, X 20 XEV, 20 XEJ	01.1989→11.1995	<b>7.20975.66.0</b>	EUV	
<b>2.0i 16V Turbo</b> 150 kW (204 PS) C 20 LET	06.1994→11.1995	<b>7.20975.66.0</b>	EUV	
<b>2.5 V6 24V</b> 125 kW (170 PS) C 25 XE	02.1993→11.1995	<b>7.20975.66.0</b>	EUV	

**VECTRA B** **14**

<b>1.6i</b> 55 kW (75 PS) X 16 SZR	10.1995→	<b>4.07501.50.0</b> <b>7.20975.66.0</b>	LLR EUV	SPi
<b>1.6i 16V</b> 74 kW (101 PS) X 16 XEL, Y 16 XE	10.1995→	<b>7.20975.66.0</b>	EUV	
<b>1.7 TD</b> 60 kW (82 PS) X 17 DT TC4EE1	10.1995→11.1996	<b>7.20975.66.0</b> <b>7.22138.50.0</b>	EUV EUV	
<b>1.8i 16V</b> 85 kW (115-116 PS) C 18 XEL, Z 18 XEL	10.1995→2002	<b>7.22449.02.0</b>	EUV	
<b>1.8i 16V</b> 85 kW (116 PS) X 18 XE, X 18 XE1	10.1995→09.2000	<b>7.20975.66.0</b> <b>7.22293.03.0</b> <b>7.22293.50.0</b> <b>7.22449.02.0</b>	EUV EUV EUV EUV	10.1996→
<b>1.8i 16V</b> 92 kW (125 PS) Z 18 XE	09.2000→	<b>7.20975.66.0</b> <b>7.22449.02.0</b>	EUV EUV	
<b>2.0i 16V</b> 100 kW (136 PS) X 20 XEV	10.1995→09.2000	<b>7.20975.66.0</b> <b>7.22293.03.0</b> <b>7.22293.50.0</b>	EUV EUV EUV	
<b>2.0 DI 16V</b> 60 kW (82 PS) X 20 DTL	11.1996→	<b>7.20975.66.0</b>	EUV	
<b>2.0 DTI 16V</b> 74 kW (101 PS) X 20 DTH	06.1997→	<b>7.20975.66.0</b>	EUV	
<b>2.2i 16V</b> 108 kW (147 PS) Z 22 SE	09.2000→	<b>7.20975.66.0</b>	EUV	
<b>2.2 DTI 16V</b> 92 kW (125 PS) Y 22 DTR	09.2000→	<b>7.20975.66.0</b>	EUV	
<b>2.5i V6 24V</b> 125 kW (170 PS) X 25 XE	10.1995→09.2000	<b>7.20975.66.0</b>	EUV	



**VECTRA B** **14**

<b>2.6 V6 24V</b> 125 kW (170 PS) Y 26 SE	09.2000→	<b>7.20975.66.0</b>	EUV	
<b>i500 2.5 V6 24V</b> 125 kW (170 PS) X 25 XE	05.1998→	<b>7.20975.66.0</b>	EUV	

**VECTRA C** **15**

<b>1.8 16V</b> 92 kW (125 PS) Z 18 XE	04.2002→	<b>7.22449.02.0</b>	EUV	
--	----------	---------------------	-----	--

**ZAFIRA** **16**

<b>1.8 16V</b> 85-92 kW (116-125 PS) X 18 XE1, Z 18 XE	04.1999→	<b>7.22449.02.0</b>	EUV	
<b>1.8i 16V</b> 85 kW (115 PS) Z 18 XEL	01.2000→	<b>7.22449.02.0</b>	EUV	



**206** **1**

<b>1.4 HDi éco 70</b> 50 kW (68 PS) DV 4 TD	09.2001→	<b>7.28328.05.0</b>	DW	
<b>2.0 HDi</b> 66 kW (90 PS) RHY	12.1999→	<b>7.28328.05.0</b>	DW	

**307** **2**

<b>1.4 HDi</b> 50 kW (68 PS) DV 4 TD	10.2001→	<b>7.28328.05.0</b>	DW	
---	----------	---------------------	----	--

--	--	--	--	--

**P**



## LAND ROVER DEFENDER

**1**
**90 2.5 TDi** 83 kW (113 PS)  
23 L

10.1995→12.1998

**7.21903.50.0**

DW

**110 2.5 TDi** 83 kW (113 PS)  
23 L

10.1995→12.1998

**7.21903.50.0**

DW

## LAND ROVER DISCOVERY

**2**
**2.5 TDi** 83-90 kW (113-122 PS)  
12 L, 19 L, 21 L

09.1989→

**7.21903.50.0**

DW

01.1999→

## RANGE ROVER

**3**
**II 2.5 TD** 100 kW (136 PS)  
25 6T (BMW)

08.1994→

**7.21903.33.0**

DW



<b>ALHAMBRA</b>					<b>1</b>
1.9 TDI 66 kW (90 PS) AHU	07.1996→02.2000	7.21895.55.0	EUV		
1.9 TDI 66 kW (90 PS) ANU	06.2000→	7.21895.55.0	EUV		
1.9 TDI 81 kW (110 PS) AFN	09.1997→02.2000	7.21903.75.0	DW		→12.2002
<b>CORDOBA</b>					<b>2</b>
1.9 SDI 47 kW (64 PS) AEY	08.1996→06.1999	7.21895.55.0	EUV		
1.9 TDI 66 kW (90 PS) AGR, AHU, ALH	12.1996→08.2002	7.21895.55.0	EUV		
1.9 TDI 81 kW (110 PS) AFN, ASK, ASV	03.1997→	7.21903.75.0	DW		
<b>IBIZA</b>					<b>3</b>
1.9 SDI 47 kW (64 PS) AEY	08.1996→06.1999	7.21895.55.0	EUV		
1.9 TDI 66 kW (90 PS) AGR, AHU, ALH, ALK	12.1996→	7.21895.55.0	EUV		
1.9 TDI 81 kW (110 PS) AFN, ASK, ASV	03.1997→	7.21903.75.0	DW		
<b>INCA</b>					<b>4</b>
1.9 SDI 47 kW (64 PS) AEY	11.1995→09.2000	7.21895.55.0	EUV		
<b>LEON</b>					<b>5</b>
1.9 TDI 66 kW (90 PS) AGR	11.1999→09.2002	7.21895.55.0	EUV		
		7.22903.01.0	DW		
1.9 TDI 66 kW (90 PS) ALH	05.2000→	7.21895.55.0	EUV		
1.9 TDI 81 kW (110 PS) AHF, ASV	11.1999→	7.21903.75.0	DW		
<b>TOLEDO</b>					<b>6</b>
1.9 TDI 66 kW (90 PS) AGR	04.1999→09.2002	7.21895.55.0	EUV		
		7.22903.01.0	DW		
1.9 TDI 66 kW (90 PS) AHU, ALH	06.1996→	7.21895.55.0	EUV		
1.9 TDI 81 kW (110 PS) AFN, AHF, ASV	12.1996→	7.21903.75.0	DW		



## FABIA

**1**
**1.9 SDi** 47 kW (64 PS)  
ASY

01.2000→

**7.21895.55.0** EUV

## OCTAVIA

**2**
**1.9 SDi** 47 kW (64 PS)  
AEY

09.1996→

**7.21895.55.0** EUV

**1.9 TDI** 66 kW (90 PS)  
AGR, ALH

10.1996→

**7.21895.55.0** EUV

**7.22903.01.0** DW

**1.9 TDI** 81 kW (110 PS)  
AHF

10.1996→

**7.21903.75.0** DW

**7.22903.01.0** DW



**ASTRA F** **1**

1.4 44 kW (60 PS) C 14 NZ	09.1991→	4.07501.50.0	LLR	SPI
1.6 i 52-55 kW (71-75 PS) C 16 NZ, X 16 SZ, X 16 SZR	09.1991→	4.07501.50.0	LLR	SPI
1.7 TD 60 kW (82 PS) X 17 DT TC4EE1	12.1991→	7.22138.50.0	EUV	
1.8 i 16V 85 kW (116 PS) C 18 XEL, X 18 XE	09.1994→12.1997	7.22293.03.0	EUV	09.1995→
2.0 i 16V 100 kW (136 PS) X 20 XEV	02.1995→09.1998	7.22293.03.0	EUV	09.1995→
		7.22293.50.0	EUV	

**ASTRA G** **2**

1.6 55 kW (75 PS) X 16 SZR	09.1998→	4.07501.50.0	LLR	SPI
-------------------------------	----------	--------------	-----	-----

**ASTRA MK IV** **3**

1.7 DTI 55 kW (75 PS) Y 17 DT	02.2000→	7.21903.10.0	DW	
		7.21903.12.0	DW	

**CORSA** **4**

1.7 DTI 55 kW (75 PS) Y 17 DT	09.2000→	7.21903.10.0	DW	
		7.21903.12.0	DW	

**VECTRA** **5**

1.6 i 55 kW (75 PS) X 16 SZR	10.1995→	4.07501.50.0	LLR	SPI
---------------------------------	----------	--------------	-----	-----

--	--	--	--	--



## BORA

1

<b>1.6 16V</b> 77 kW (105 PS) ATN, AUS, AZD, BCB	11.1999→05.2003	<b>7.21704.50.0</b> <b>7.22880.01.0</b> <b>7.28098.04.0</b>	EUV EUV EUV	
<b>1.6 16V FSI</b> 81 kW (110 PS) BAD	08.2001→05.2003	<b>7.21704.50.0</b> <b>7.22880.01.0</b> <b>7.28098.04.0</b>	EUV EUV EUV	
<b>1.8 20V Turbo</b> 110-132 kW (150-180 PS) AGU, ARX, ARY, AUQ	09.2000→	<b>7.21704.50.0</b> <b>7.22880.01.0</b> <b>7.28098.04.0</b>	EUV EUV EUV	
<b>1.8 20V Turbo</b> 110 kW (150 PS) AUM	09.2000→	<b>7.21704.50.0</b> <b>7.22687.07.0</b> <b>7.22880.01.0</b> <b>7.28098.04.0</b>	EUV EUV EUV EUV	→12.2002
<b>1.9 SDI</b> 50 kW (68 PS) AGP	05.2000→04.2001	<b>7.21704.50.0</b>	EUV	
<b>1.9 SDI</b> 50 kW (68 PS) AQM	11.1998→	<b>7.21704.50.0</b> <b>7.22903.01.0</b>	EUV DW	
<b>1.9 TDI</b> 66 kW (90 PS) AGR	10.1998→	<b>7.21704.50.0</b> <b>7.21895.55.0</b> <b>7.22903.01.0</b>	EUV EUV DW	<b>FZG</b> 1J-Y-000 001→
<b>1.9 TDI</b> 66 kW (90 PS) ALH	09.1998→	<b>7.21704.50.0</b> <b>7.21895.55.0</b> <b>7.21903.70.0</b> <b>7.21903.75.0</b> <b>7.22903.01.0</b> <b>7.22903.04.0</b>	EUV EUV DW DW DW DW	<b>FZG</b> →1J-X-999 000 <b>FZG</b> →1J-X-999 000 <b>FZG</b> 1J-Y-000 001→ <b>FZG</b> 1J-Y-000 001→
<b>1.9 TDI</b> 74-85 kW (100-115 PS) AHF, ATD, AUY, AXR	09.1998→05.2003	<b>7.21704.50.0</b> <b>7.21903.70.0</b>  <b>7.21903.75.0</b>  <b>7.22903.01.0</b>  <b>7.22903.04.0</b>	EUV DW  DW  DW  DW	<b>MOT</b> AHF: →04.2000, <b>FZG</b> →1J-X-999 000 <b>MOT</b> ATD, AXR: →12.2001, <b>FZG</b> →1J-X-999 000 <b>MOT</b> AUY: <b>FZG</b> →1J-X-999 000 <b>MOT</b> AHF: →04.2000, <b>FZG</b> →1J-X-999 000 <b>MOT</b> ATD, AXR: →12.2001, <b>FZG</b> →1J-X-999 000 <b>MOT</b> AUY: <b>FZG</b> →1J-X-999 000 <b>MOT</b> AHF: →04.2000, <b>FZG</b> 1J-Y-000 001→ <b>MOT</b> ATD, AXR: →12.2001, <b>FZG</b> 1J-Y-000 001→ <b>MOT</b> AUY: <b>FZG</b> 1J-Y-000 001→ <b>MOT</b> AHF: →04.2000, <b>FZG</b> 1J-H-000 001→ <b>MOT</b> ATD, AXR: →12.2001, <b>FZG</b> 1J-Y-000 001→ <b>MOT</b> AUY: <b>FZG</b> 1J-Y-000 001→
<b>1.9 TDI</b> 81-96 kW (110-130 PS) ASV, ASZ, AVG	09.1998→	<b>7.21704.50.0</b>	EUV	
<b>1.9 TDI</b> 85 kW (115 PS) AJM	11.1998→07.2001	<b>7.21704.50.0</b> <b>7.21903.75.0</b> <b>7.22903.01.0</b> <b>7.22903.04.0</b>	EUV DW DW DW	<b>FZG</b> →1J-X-999 000 <b>FZG</b> 1J-Y-000 001→ <b>FZG</b> 1J-Y-000 001→
<b>1.9 TDI</b> 110 kW (150 PS) ARL	09.2000→	<b>7.21704.50.0</b> <b>7.22903.01.0</b>	EUV DW	
<b>2.5 V6 TDI</b>	01.2000→	<b>7.21704.50.0</b> <b>7.22880.01.0</b> <b>7.28098.04.0</b>	EUV EUV EUV	
<b>2.8 V6 24V</b> 150 kW (204 PS) AQP, AUE, BDE	05.1999→05.2003	<b>7.21704.50.0</b> <b>7.22880.01.0</b> <b>7.28098.04.0</b>	EUV EUV EUV	

V



<b>CADDY</b>					<b>2</b>
<b>1.9 SDI</b> 47 kW (64 PS) AEY	11.1995→09.2000	<b>7.21895.55.0</b>	EUV		
		<b>7.21903.70.0</b>	DW		
<b>1.9 TDI</b> 66 kW (90 PS) AHU, ALE	10.1996→09.2000	<b>7.21895.55.0</b>	EUV		
		<b>7.21903.70.0</b>	DW		
<b>GOLF I</b>					<b>3</b>
<b>Golf 1.8 GTI</b> 82 kW (112 PS) DX	08.1982→12.1983	<b>7.21704.50.0</b>	EUV		
<b>GOLF II</b>					<b>4</b>
<b>Golf 1.05</b> 33 kW (45 PS) HZ	08.1985→10.1991	<b>7.21704.50.0</b>	EUV		
<b>Golf 1.8 G 60</b> 110-118 kW (150-160 PS) PG, 1H	08.1988→07.1991	<b>7.21704.50.0</b>	EUV		
<b>Golf 1.8 GTI</b> 79-82 kW (107-112 PS) DX, EV, PB, PF, RD	08.1983→07.1992	<b>7.21704.50.0</b>	EUV		
<b>Golf 1.8 GTI 16V</b> 95-98 kW (129-133 PS) KR, PL	02.1986→10.1991	<b>7.21704.50.0</b>	EUV		
<b>GOLF III</b>					<b>5</b>
<b>Golf 1.8</b> 66 kW (90 PS) ABS, ADZ	11.1991→10.2000	<b>7.21483.54.0</b>	DW		
<b>Golf 1.9 D</b> 47 kW (64 PS) 1Y	11.1991→02.1999	<b>7.21903.70.0</b>	DW	01.1995→	
<b>Golf 1.9 SDI</b> 47 kW (64 PS) AEY	07.1995→02.1999	<b>7.21895.55.0</b>	EUV		
		<b>7.21903.70.0</b>	DW		
<b>Golf 1.9 TDI</b> 66 kW (90 PS) AHU, ALE	05.1996→10.2000	<b>7.21895.55.0</b>	EUV		
		<b>7.21903.70.0</b>	DW		
<b>Golf 1.9 TDI</b> 66 kW (90 PS) 1Z	07.1993→07.1996	<b>7.21903.70.0</b>	DW		
<b>Golf 1.9 TDI</b> 81 kW (110 PS) AFN	02.1996→08.1999	<b>7.21903.70.0</b>	DW		
		<b>7.21903.75.0</b>	DW		
<b>GOLF IV</b>					<b>6</b>
<b>Golf 1.6</b> 74 kW (100 PS) AEH	01.1998→	<b>7.22402.50.0</b>	EUV	01.1999→	
		<b>7.22880.01.0</b>	EUV		
		<b>7.28098.04.0</b>	EUV		
<b>Golf 1.6</b> 74 kW (100 PS) APF	05.1999→08.2000	<b>7.21704.50.0</b>	EUV		
		<b>7.22402.50.0</b>	EUV		
		<b>7.22880.01.0</b>	EUV		
		<b>7.28098.04.0</b>	EUV		
<b>Golf 1.6</b> 75 kW (102 PS) AVU, BFQ	09.2000→	<b>7.22880.01.0</b>	EUV		
		<b>7.28098.04.0</b>	EUV		
<b>Golf 1.6 16V</b> 77 kW (105 PS) ATN, AUS, AZD, BCB	11.1999→	<b>7.21704.50.0</b>	EUV		
		<b>7.22880.01.0</b>	EUV		
		<b>7.28098.04.0</b>	EUV		
<b>Golf 1.6 16V FSI</b> 81-85 kW (110-115 PS) BAD, BAG	08.2001→	<b>7.21704.50.0</b>	EUV		
		<b>7.22880.01.0</b>	EUV		
		<b>7.28098.04.0</b>	EUV		
<b>Golf 1.8 GTI</b> 132 kW (180 PS) ARY, AUQ	08.2001→	<b>7.21704.50.0</b>	EUV		
		<b>7.22880.01.0</b>	EUV		
		<b>7.28098.04.0</b>	EUV		
<b>Golf 1.8 20V Turbo</b> 110 kW (150 PS) AUM	09.2000→	<b>7.21704.50.0</b>	EUV	→12.2002	
		<b>7.22687.07.0</b>	EUV	→12.2002	
<b>Golf 1.9 SDI</b> 50 kW (68 PS) AGP, AQM	10.1997→	<b>7.21903.70.0</b>	DW	<b>FZG</b> 1J-X-999 000→	
		<b>7.22903.01.0</b>	DW	→12.2001, <b>FZG</b> 1J-Y-000 001→	



## GOLF IV

6

Golf 1.9 TDI 66 kW (90 PS) AGR	10.1997→	7.21895.55.0	EUV	<b>FZG</b> 1J-Y-999 000→1J-X-999 000 <b>FZG</b> 1J-Y-000 001→
		7.21903.70.0	DW	
		7.22903.01.0	DW	
Golf 1.9 TDI 66 kW (90 PS) ALH	10.1997→05.2000	7.21895.55.0	EUV	<b>FZG</b> →1J-X-999 000 <b>FZG</b> →1J-X-999 000 <b>FZG</b> 1J-Y-000 001→ <b>FZG</b> 1J-Y-000 001→
		7.21903.70.0	DW	
		7.21903.75.0	DW	
		7.22903.01.0	DW	
		7.22903.04.0	DW	
Golf 1.9 TDI 74 kW (100-101 PS) ATD, AXR	02.2000→	7.21903.70.0	DW	→12.2001, <b>FZG</b> 1J-Y-000 001→1J-X-999 000 →12.2001, <b>FZG</b> 1J-Y-000 001→ →12.2001, <b>FZG</b> 1J-Y-000 001→
		7.22903.01.0	DW	
		7.22903.04.0	DW	
Golf 1.9 TDI 81-85 kW (110-115 PS) AHF, AJM, ASV, AUY	10.1997→	7.21903.70.0	DW	<b>MOT</b> AHF: <b>FZG</b> 1J-Y-999 000→1J-X-999 000 <b>MOT</b> AJM, AUY: <b>FZG</b> →1J-X-999 000 <b>MOT</b> ASV: <b>FZG</b> 1J-Y-000 001→1J-X-999 000 <b>FZG</b> →1J-X-999 000 <b>FZG</b> 1J-Y-000 001→ <b>FZG</b> 1J-Y-000 001→
		7.21903.75.0	DW	
		7.22903.01.0	DW	
		7.22903.04.0	DW	
		7.22903.04.0	DW	
Golf 1.9 TDI 110 kW (150 PS) ARL	09.2000→	7.22903.02.0	DW	→12.2001
Golf 2.0 85-88 kW (115-120 PS) ABA, AQY, ATF, AWG, AZG, AZH, AZJ	08.1998→	7.28098.04.0	EUV	
Golf 2.0 85 kW (115 PS) APK	08.1998→	7.21704.50.0	EUV	
Golf 2.0 (Bi-Fuel) 85 kW (116 PS) BEH	05.2002→	7.28098.04.0	EUV	
		7.21704.50.0	EUV	
		7.22880.01.0	EUV	
Golf 2.0 (Europa) 85 kW (115 PS) AWF, AWG	04.2002→06.2002	7.28098.04.0	EUV	
		7.21704.50.0	EUV	
		7.22880.01.0	EUV	
Golf 2.0 4motion 85 kW (115-116 PS) AZH, AZJ	04.2000→	7.28098.04.0	EUV	
		7.21704.50.0	EUV	
		7.22880.01.0	EUV	
Golf 2.3 V5 20V 125 kW (170 PS) AQN	09.2000→	7.28098.04.0	EUV	
		7.21704.50.0	EUV	
		7.22880.01.0	EUV	
Golf 2.8 V6 24V 130-150 kW (177-204 PS) AFP, AQP, AUE, BDE	12.1998→	7.28098.04.0	EUV	
		7.21704.50.0	EUV	
		7.22880.01.0	EUV	
Golf 2.8 V6 4motion 150 kW (204 PS) AQP	05.1999→05.2000	7.28098.04.0	EUV	
		7.21704.50.0	EUV	
		7.22880.01.0	EUV	
Golf R32	08.2002→	7.28098.04.0	EUV	
		7.21704.50.0	EUV	
		7.22880.01.0	EUV	

## GOLF V

7

Golf 1.4 16V FSI 66 kW (90 PS) BKG	10.2003→	7.22880.01.0	EUV	
		7.28098.04.0	EUV	
Golf 1.6 16V FSI		7.21704.50.0	EUV	
Golf 1.9 TDI 77 kW (105 PS) BJB, BKC	10.2003→	7.22880.01.0	EUV	
		7.28098.04.0	EUV	

**GOLF V** **7**

<b>Golf 2.0 TDI</b> 100-103 kW (136-140 PS) AZV, BKD	10.2003→	<b>7.22880.01.0</b> <b>7.28098.04.0</b>	EUV EUV	
<b>Golf 2.0 16V FSI</b> 110 kW (150 PS) AXW	01.2004→	<b>7.22880.01.0</b> <b>7.28098.04.0</b>	EUV EUV	
<b>Golf R32</b> 177 kW (241 PS) BML	10.2003→	<b>7.21704.50.0</b> <b>7.22880.01.0</b> <b>7.28098.04.0</b>	EUV EUV EUV	

**LT** **8**

<b>28</b> 105 kW (143 PS) AGL	05.1996→11.2001	<b>7.21071.50.0</b>	EUV	
<b>28 SDI</b> 55 kW (75 PS) AGX	05.1996→04.2001	<b>7.21071.50.0</b> <b>7.21903.70.0</b>	EUV DW	
<b>28 TDI</b> 66 kW (90 PS) APA	05.1999→04.2001	<b>7.21071.50.0</b> <b>7.21903.70.0</b>	EUV DW	
<b>28 TDI</b> 75 kW (102 PS) AHD	05.1996→05.1999	<b>7.21071.50.0</b> <b>7.21903.70.0</b>	EUV DW	
<b>28 TDI</b> 80 kW (109 PS) ANJ	06.1999→	<b>7.21071.50.0</b>	EUV	→12.2001
<b>35</b> 105 kW (143 PS) AGL	05.1996→11.2001	<b>7.21071.50.0</b>	EUV	
<b>35 SDI</b> 55 kW (75 PS) AGX	05.1996→04.2001	<b>7.21071.50.0</b> <b>7.21903.70.0</b>	EUV DW	
<b>35 TDI</b> 66 kW (90 PS) APA	05.1999→04.2001	<b>7.21071.50.0</b> <b>7.21903.70.0</b>	EUV DW	
<b>35 TDI</b> 75 kW (102 PS) AHD	05.1996→05.1999	<b>7.21071.50.0</b> <b>7.21903.70.0</b>	EUV DW	
<b>35 TDI</b> 80 kW (109 PS) ANJ	06.1999→	<b>7.21071.50.0</b>	EUV	→12.2001
<b>40</b> 105 kW (143 PS) AGL	05.1996→11.2001	<b>7.21071.50.0</b>	EUV	
<b>45</b> 105 kW (143 PS) AGL	05.1996→11.2001	<b>7.21071.50.0</b>	EUV	
<b>46</b> 105 kW (143 PS) AGL	05.1996→11.2001	<b>7.21071.50.0</b>	EUV	
<b>46 TDI</b> 66 kW (90 PS) APA	05.1999→04.2001	<b>7.21071.50.0</b> <b>7.21903.70.0</b>	EUV DW	
<b>46 TDI</b> 75 kW (102 PS) AHD	05.1996→05.1999	<b>7.21071.50.0</b> <b>7.21903.70.0</b>	EUV DW	

**LUPO** **9**

<b>1.2 TDI</b> 45 kW (61 PS) ANY	06.1999→11.2000	<b>7.21903.70.0</b> <b>7.21903.75.0</b>	DW DW	
<b>1.4 16V FSI</b> 77 kW (105 PS) ARR	09.2000→09.2003	<b>7.28098.04.0</b>	EUV	
<b>1.4 TDI</b> 55 kW (75 PS) AMF	05.1999→	<b>7.21903.70.0</b> <b>7.28098.04.0</b>	DW EUV	→12.2001
<b>1.6 16V GTI</b> 92 kW (125 PS) AVY	06.2000→	<b>7.28098.04.0</b>	EUV	
<b>1.7 SDI</b> 44 kW (60 PS) AKU	10.1998→	<b>7.21903.75.0</b>	DW	

**NEW BEETLE** **10**

<b>1.6</b> 74-75 kW (101-102 PS) AWH, AYD	11.1999→	<b>7.22402.50.0</b>	EUV	<b>MOT</b> AYD: →12.2002
<b>1.9 TDI</b> 66 kW (90 PS) ALH	11.1998→	<b>7.21895.55.0</b> <b>7.22903.01.0</b>	EUV DW	



## NEW BEETLE

**10**
**1.9 TDI (USA)** 66 kW (90 PS)  
ALH

11.1998→

**7.21895.55.0** EUV  
**7.22903.01.0** DW

## PASSAT

**11**
**1.6** 74 kW (100 PS)  
AHL, ANA, ARM

10.1996→08.2000

**7.22402.50.0** EUV

**MOT** AHL, ARM: 01.2000→

**1.8 20V** 92 kW (125 PS)  
ADR

12.1996→01.1999

**7.21704.50.0** EUV

**7.22402.50.0** EUV

MT

**1.8 20V** 92 kW (125 PS)  
APT, ARG

01.1999→08.2000

**7.22402.50.0** EUV

**MOT** APT:  
MT  
**MOT** ARG:  
AT

**1.8 20V Turbo** 110 kW (150 PS)  
AWT

10.2000→

**7.21704.50.0** EUV

→12.2002

**1.8 20V Turbo (MEX)** 125 kW (170 PS)  
AWM

02.2001→

**7.22880.01.0** EUV

**1.9 TDI** 66 kW (90 PS)  
AHH, AHU

08.1996→08.2000

**7.21895.55.0** EUV

**7.21903.70.0** DW

**7.21903.75.0** DW

**1.9 TDI** 74-96 kW (100-130 PS)  
AVB, AVF, AWX

10.2000→

**7.22903.01.0** DW

**7.22903.04.0** DW

**1.9 TDI** 81-85 kW (110-115 PS)  
AFN, AJM, ATJ, AVG

03.1996→08.2000

**7.21903.70.0** DW

**7.21903.75.0** DW

**MOT** AFN, AVG: 01.1998→

**2.3 V5 4motion** 125 kW (170 PS)  
AZX

01.2001→

**7.22880.01.0** EUV

**2.8 V6** 140 kW (190 PS)  
ATX

09.1999→08.2000

**7.21704.50.0** EUV

**2.8 V6 30V** 132-142 kW (180-193 PS)  
ACK, AGE, ALG, AMX, APR, AOD,  
ATQ

05.1997→

**7.21704.50.0** EUV

**MOT** ACK, ALG: →12.1998  
**MOT** AMX, ATQ: 01.2001→12.2002

**2.8 V6 4motion** 140 kW (190 PS)  
ATX

09.1999→08.2000

**7.21704.50.0** EUV

**4.0 W8** 202 kW (275 PS)  
BDN, BDP

09.2001→

**7.22880.01.0** EUV

**4.0 W8 (J)** 202 kW (275 PS)  
BDN, BDP

06.2002→

**7.22880.01.0** EUV

**4.0 W8 (MEX)**

11.2001→04.2002

**7.22880.01.0** EUV

## PHAETON

**12**
**3.2 V6 24V** 177 kW (240 PS)  
AYT, BKL

05.2002→

**7.22880.01.0** EUV

**7.28098.04.0** EUV

**4.2 V8** 246 kW (334 PS)  
BGH, BGJ

05.2003→

**7.22880.01.0** EUV

**7.28098.04.0** EUV

**5.0 V10 TDI** 230 kW (310 PS)  
AJS

11.2002→

**7.22880.01.0** EUV

**7.28098.04.0** EUV

**6.0 W12 48V** 309 kW (420 PS)  
BAN

06.2002→

**7.22880.01.0** EUV

**7.28098.04.0** EUV

**V**

## POLO

**13**
**1.2** 40 kW (54 PS)  
AWY

01.2002→

**7.22880.01.0** EUV

**1.2 12V** 47 kW (64 PS)  
AZQ

11.2001→

**7.22880.01.0** EUV

**1.4 16V FSI** 63 kW (85 PS)  
AXU

02.2002→

**7.22880.01.0** EUV

**1.4 TDI** 55 kW (75 PS)  
AMF

10.1999→

**7.21903.70.0** DW

**1.6** 74 kW (100 PS)  
AEH, AKL

10.1999→09.2001

**7.22402.50.0** EUV



<b>POLO</b>					<b>13</b>
<b>1.6 16V GTI</b> 92 kW (125 PS) AVY	05.2000→09.2001	<b>7.22880.01.0</b>	EUV		
<b>1.7 SDI</b> 42 kW (57 PS) AKW	11.1997→08.1999	<b>7.21903.70.0</b>	DW		
<b>1.7 SDI</b> 44 kW (60 PS) AKU	08.1997→04.2000	<b>7.21903.75.0</b>	DW		
<b>1.9 D</b> 47-50 kW (64-68 PS) AEF	10.1994→04.1998	<b>7.21895.55.0</b>	EUV		
<b>1.9 SDI</b> 47 kW (64 PS) AEY	12.1995→08.1999	<b>7.21895.55.0</b> <b>7.21903.70.0</b>	EUV DW		
<b>1.9 SDI</b> 47 kW (64 PS) AGD, ASX	07.1996→09.2001	<b>7.21903.75.0</b>	DW	12.2000→	
<b>1.9 SDI</b> 50 kW (68 PS) AGP, AQM	10.1999→09.2001	<b>7.21903.70.0</b>	DW	01.2001→	
<b>1.9 TDI</b> 66 kW (90 PS) AGR, AHU, ALE	01.1997→09.2001	<b>7.21895.55.0</b> <b>7.21903.70.0</b>	EUV DW		<b>MOT</b> AGR: 01.1999→ <b>MOT</b> AHU: →10.1997 <b>MOT</b> ALE: 11.1997→12.1999
<b>1.9 TDI</b> 66 kW (90 PS) ALH	10.1999→09.2001	<b>7.21895.55.0</b> <b>7.21903.70.0</b> <b>7.21903.75.0</b>	EUV DW DW	01.2001→ 01.2001→	
<b>1.9 TDI</b> 81 kW (110 PS) AFN, ASV	06.1998→09.2001	<b>7.21903.70.0</b>  <b>7.21903.75.0</b>	DW  DW		<b>MOT</b> AFN: →12.1999 <b>MOT</b> ASV: 01.2001→ <b>MOT</b> AFN: →12.1999 <b>MOT</b> ASV: 01.2001→
<b>SHARAN</b>					<b>14</b>
<b>1.9 TDI</b> 66 kW (90 PS) AHU	09.1996→02.2000	<b>7.21895.55.0</b> <b>7.21903.70.0</b>	EUV DW		
<b>1.9 TDI</b> 66 kW (90 PS) ANU	03.1999→	<b>7.21895.55.0</b> <b>7.21903.70.0</b> <b>7.22903.01.0</b>	EUV DW DW	→12.2000 01.2001→	
<b>1.9 TDI</b> 81 kW (110 PS) AFN, AVG	12.1996→02.2000	<b>7.21903.70.0</b> <b>7.21903.75.0</b>	DW DW		
<b>1.9 TDI</b> 85 kW (115 PS) AUY	04.2000→	<b>7.22903.01.0</b> <b>7.22903.04.0</b>	DW DW		
<b>TOUAREG</b>					<b>15</b>
<b>5.0 V10 TDI</b> 230 kW (310 PS) AYH	11.2002→	<b>7.22880.01.0</b> <b>7.28098.04.0</b>	EUV EUV		
<b>TOURAN</b>					<b>16</b>
<b>1.6 FSI</b> 75-85 kW (102-115 PS) BAG, BGU	02.2003→	<b>7.22880.01.0</b>	EUV		
<b>1.9 TDI</b> 74-77 kW (100-105 PS) AVQ, BKC	02.2003→	<b>7.22880.01.0</b>	EUV		
<b>2.0 FSI</b> 110 kW (150 PS) AXW	10.2003→	<b>7.22880.01.0</b>	EUV		
<b>2.0 TDI</b> 100-103 kW (136-140 PS) AZV, BKD	02.2003→	<b>7.22880.01.0</b>	EUV		
<b>TRANSPORTER T4</b>					<b>17</b>
<b>2.5 TDI</b> 65-75 kW (88-102 PS) ACV, AJT, AUF	09.1995→	<b>7.21903.70.0</b>	DW		<b>MOT</b> ACV, AUF: →12.2001 <b>MOT</b> AJT: 01.1999→12.2001
<b>2.5 TDI</b> 111 kW (151 PS) AHY	05.1998→09.2000	<b>7.21903.70.0</b> <b>7.21903.75.0</b>	DW DW	01.1999→12.2001	
<b>2.8 V6</b> 150 kW (204 PS) AMV	05.2000→	<b>7.28098.04.0</b>	EUV		

**V**



## TRANSPORTER T5

**18**

<b>1.9 TDI</b> 63-77 kW (85-105 PS) AXB, AXC	04.2003→	<b>7.28098.04.0</b>	EUV	
<b>2.0</b> 85 kW (115 PS) AXA	11.2003→	<b>7.28098.04.0</b>	EUV	
<b>2.5 TDI</b> 96-128 kW (130-174 PS) AXD, AXE, BLJ	04.2003→	<b>7.28098.04.0</b>	EUV	
<b>3.2 VR6</b> 170-173 kW (231-235 PS) BDL, BKK	05.2003→	<b>7.28098.04.0</b>	EUV	

## VENTO

**19**

<b>1.9 D</b> 47 kW (64 PS) 1Y	01.1992→12.1997	<b>7.21903.70.0</b>	DW	01.1995→
<b>1.9 SDI</b> 47 kW (64 PS) AEY	07.1995→12.1997	<b>7.21895.55.0</b>	EUV	
		<b>7.21903.70.0</b>	DW	
<b>1.9 TDI</b> 66 kW (90 PS) AHU, ALE	08.1996→12.1997	<b>7.21895.55.0</b>	EUV	
		<b>7.21903.70.0</b>	DW	
<b>1.9 TDI</b> 66 kW (90 PS) 1Z	07.1993→07.1996	<b>7.21903.70.0</b>	DW	
<b>1.9 TDI</b> 81 kW (110 PS) AFN	02.1996→12.1997	<b>7.21903.70.0</b>	DW	
		<b>7.21903.75.0</b>	DW	



<b>240</b>					<b>1</b>
2.3 96-98 kW (131-133 PS) B 230 E	08.1983→07.1985	<b>7.20271.52.0</b>	UAV		
<b>740</b>					<b>2</b>
2.3 96-98 kW (131-133 PS) B 230 E	08.1984→07.1991	<b>7.20271.52.0</b>	UAV		
<b>850</b>					<b>3</b>
2.0 105 kW (143 PS) B 5204 F	06.1991→12.1996	<b>7.21980.50.0</b>	EUV	08.1992→09.1995	
2.0 20V Turbo 155 kW (210 PS) B 5204 T	08.1993→12.1996	<b>7.21980.50.0</b>	EUV	→09.1995	
2.4 106 kW (144 PS) B 5252 S	08.1994→12.1996	<b>7.21980.50.0</b>	EUV	→09.1995	
2.4 20V 121-125 kW (165-170 PS) B 5254 S	09.1992→12.1996	<b>7.21980.50.0</b>	EUV	→09.1995	
2.4 20V Turbo 166 kW (225 PS) B 5234 FT	09.1992→12.1996	<b>7.21980.50.0</b>	EUV	→09.1995	
2.5 TDI 103 kW (140 PS) D 5252 T	08.1995→12.1996	<b>7.21681.51.0</b>	LDRV		
<b>S 40</b>					<b>4</b>
1.6 16V 77 kW (105 PS) B 4164 S	09.1995→08.1999	<b>7.22240.09.0</b>	EUV	01.1998→	
1.6 16V 80 kW (109 PS) B 4164 S2	03.1999→	<b>7.22240.08.0</b>	EUV	01.2001→	
		<b>7.22240.09.0</b>	EUV	→12.2000	
		<b>7.22517.04.0</b>	AKF		
1.8 16V 85 kW (116 PS) B 4184 S	07.1995→08.1999	<b>7.22240.09.0</b>	EUV		
1.8i 16V 92 kW (125 PS) B 4184 SM	03.1998→2001	<b>7.22240.08.0</b>	EUV		
		<b>7.22240.09.0</b>	EUV	→12.2000	
		<b>7.22517.04.0</b>	AKF		
1.9 TDI 70-85 kW (95-115 PS) D 4192 T2, D 4192 T3, D 4192 T4	03.1999→	<b>7.21903.44.0</b>	DW		
2.0 16V 100 kW (136 PS) B 4204 S	03.1996→	<b>7.22240.08.0</b>	EUV	01.2001→	
		<b>7.22240.09.0</b>	EUV		
		<b>7.22517.04.0</b>	AKF		
2.0 16V Turbo 118 kW (160 PS) B 4204 T	10.1997→07.2000	<b>7.22240.09.0</b>	EUV		
		<b>7.22517.04.0</b>	AKF		
<b>V 40</b>					<b>5</b>
1.6 16V 77 kW (105 PS) B 4164 S	09.1995→08.1999	<b>7.22240.09.0</b>	EUV		
1.6 16V 80 kW (109 PS) B 4164 S2	03.1999→	<b>7.22240.08.0</b>	EUV	01.2001→	
		<b>7.22240.09.0</b>	EUV	→12.2000	
		<b>7.22517.04.0</b>	AKF		
1.8 16V 85 kW (116 PS) B 4184 S	07.1995→08.1999	<b>7.22240.09.0</b>	EUV		
1.8i 16V 92 kW (125 PS) B 4184 SM	03.1998→2001	<b>7.22240.08.0</b>	EUV		
		<b>7.22240.09.0</b>	EUV	→12.2000	
		<b>7.22517.04.0</b>	AKF		
1.9 TDI 70-85 kW (95-115 PS) D 4192 T2, D 4192 T3, D 4192 T4	03.1999→	<b>7.21903.44.0</b>	DW		
2.0 16V 100 kW (136 PS) B 4204 S	03.1996→	<b>7.22240.08.0</b>	EUV	01.2001→	
		<b>7.22240.09.0</b>	EUV		
		<b>7.22517.04.0</b>	AKF		
2.0 16V Turbo 118 kW (160 PS) B 4204 T	10.1997→07.2000	<b>7.22240.09.0</b>	EUV		
		<b>7.22517.04.0</b>	AKF		

**V**

**S 60****6**

<b>2.4 20V</b> 103 kW (140 PS) B 5244 S2	11.2000→	<b>7.22240.08.0</b> <b>7.22517.04.0</b>	EUV AKF	
<b>2.4 20V Turbo</b> 147 kW (200 PS) B 5244 T5	11.2000→	<b>7.22240.08.0</b> <b>7.22517.04.0</b>	EUV AKF	

**C 70 COUPÉ****7**

<b>C 70 Coupé 2.0 20V Turbo</b> 120-166 kW (163-226 PS) B 5204 T2, B 5204 T3	03.1997→	<b>7.22240.08.0</b> <b>7.22517.04.0</b>	EUV AKF	01.2001→
<b>C 70 Coupé 2.3 20V T5 Turbo</b> 184 kW (250 PS) B 5234 T3	03.1997→	<b>7.22240.08.0</b> <b>7.22517.04.0</b>	EUV AKF	01.2001→
<b>C 70 Coupé 2.4 20V</b> 121-143 kW (165-195 PS) B 5254 S, B 5254 T	01.1997→	<b>7.22240.08.0</b> <b>7.22517.04.0</b>	EUV AKF	01.2001→

**C 70 Convertible****8**

<b>2.0 20V Turbo</b> 120-166 kW (163-226 PS) B 5204 T2, B 5204 T3	03.1998→	<b>7.22517.04.0</b>	AKF	
<b>2.3 20V T5 Turbo</b> 184 kW (250 PS) B 5234 T3	03.1998→	<b>7.22517.04.0</b>	AKF	
<b>2.5 20V Turbo</b> 121-143 kW (165-195 PS) B 5254 S, B 5254 T	03.1998→	<b>7.22517.04.0</b>	AKF	

**S 70****9**

<b>2.0</b> 93 kW (126 PS) B 5202 S	01.1997→	<b>7.22517.04.0</b>	AKF	
<b>2.0 20V Turbo</b> 120-166 kW (163-226 PS) B 5204 T, B 5204 T2, B 5204 T3	01.1997→	<b>7.22240.09.0</b> <b>7.22517.04.0</b>	EUV AKF	
<b>2.3 20V Turbo</b> 166 kW (225 PS) B 5234 FT	01.1997→	<b>7.22240.09.0</b> <b>7.22517.04.0</b>	EUV AKF	
<b>2.3 20V T5 Turbo</b> 184 kW (250 PS) B 5234 T3	01.1997→	<b>7.22240.09.0</b> <b>7.22517.04.0</b>	EUV AKF	
<b>2.4 20V Turbo</b> 143 kW (195 PS) B 5254 T	01.1997→	<b>7.22240.09.0</b> <b>7.22517.04.0</b>	EUV AKF	
<b>2.4 20V (Gas)</b> 103 kW (140 PS) B 5244 SG	07.1999→	<b>7.22240.09.0</b> <b>7.22517.04.0</b>	EUV AKF	
<b>2.5</b> 106 kW (144 PS) B 5252 S	01.1997→	<b>7.22240.09.0</b> <b>7.22517.04.0</b>	EUV AKF	
<b>2.5 (Gas)</b> 106 kW (144 PS) GB 5252 S	10.1998→	<b>7.22240.09.0</b> <b>7.22517.04.0</b>	EUV AKF	

**V 70 I****10**

<b>2.0</b> 93 kW (126 PS) B 5202 S	01.1997→03.2000	<b>7.22240.09.0</b>	EUV	
<b>2.0 20V Turbo</b> 120-166 kW (163-226 PS) B 5204 T, B 5204 T2, B 5204 T3	01.1997→03.2000	<b>7.22240.09.0</b>	EUV	
<b>2.3 20V Turbo</b> 166 kW (225 PS) B 5234 FT	01.1997→03.2000	<b>7.22240.09.0</b>	EUV	
<b>2.3 T5 20V Turbo</b> 184 kW (250 PS) B 5234 T3	01.1997→03.2000	<b>7.22240.09.0</b>	EUV	
<b>2.4 20V Turbo</b> 143 kW (195 PS) B 5254 T	01.1997→03.2000	<b>7.22240.09.0</b>	EUV	
<b>2.4 20V (Gas)</b> 103 kW (140 PS) B 5244 SG	08.1999→03.2000	<b>7.22240.09.0</b>	EUV	

V



**S 80**

**11**

<b>2.0 20V Turbo</b> 120-166 kW (163-226 PS) B 5204 T3, B 5204 T4	06.1998→	<b>7.22240.08.0</b> <b>7.22517.04.0</b>	EUV AKF	01.2001→
<b>2.4 20V</b> 125 kW (170 PS) B 5244 S	01.1999→	<b>7.22517.04.0</b>	AKF	
<b>2.8 24V T6 Turbo</b> 200 kW (272 PS) B 6284 T	05.1998→	<b>7.22240.08.0</b> <b>7.22517.04.0</b>	EUV AKF	01.2001→
<b>3.0 24V</b> 147-150 kW (200-204 PS) B 6294 S, B 6304 S3	05.1998→	<b>7.22240.08.0</b> <b>7.22517.04.0</b>	EUV AKF	01.2001→

V





Ⓓ Referenzliste OE-Nr. → Pierburg-Nr.

---

ⒼⒷ Cross reference OE no. → Pierburg no.

---

Ⓕ Comparaison No. OE → No. Pierburg

---

Ⓔ Comparación No. OE → No. Pierburg

---

Ⓘ Comparazione N. OE → N. Pierburg

---





# CROSS REFERENCE

CROSS REFERENCE

OE-No.		OE-No.	
<b>ALFA ROMEO</b>		<b>MERCEDES-BENZ</b>	
467 68 2500	7.21903.48.0	A 000 072 18 17	7.20229.50.0
467 682 50	7.21903.48.0	A 000 072 19 17	7.20229.50.0
<b>AUDI</b>		A 000 072 27 17	7.20524.50.0
026 906 283 H	7.21704.50.0	A 000 072 28 17	7.20733.51.0
028 906 283 A	7.21895.55.0	A 000 072 46 17	7.20733.51.0
028 906 283 F	7.21895.55.0	A 000 140 64 60	7.21071.50.0
028 906 283 J	7.21895.55.0	A 001 540 00 97	7.21071.50.0
034 906 283	7.21239.50.0	A 001 540 08 97	7.21071.50.0
037 906 283 A	7.22402.50.0	A 001 540 14 97	7.21071.50.0
037 906 283 C	7.22880.01.0	A 001 540 15 97	7.21071.50.0
037 906 283 D	7.28098.04.0	A 001 540 20 97	7.21071.50.0
054 906 267	7.21483.54.0	A 001 540 35 97	7.21071.50.0
054 906 267 A	7.21483.54.0	A 001 540 70 97	7.21071.50.0
059 906 627	7.21903.51.0	A 001 540 86 97	7.21071.50.0
059 906 627 A	7.21903.49.0	A 002 540 18 97	7.22355.01.0
059 906 627 B	7.22903.17.0	000 072 18 17	7.20229.50.0
059 906 627 C	7.22903.16.0	000 072 19 17	7.20229.50.0
077 906 283	7.22402.51.0	000 072 27 17	7.20524.50.0
078 133 455 D	4.07501.52.0	000 072 28 17	7.20733.51.0
078 133 517	7.21798.83.0	000 072 46 17	7.20733.51.0
078 133 517 E	7.21798.83.0	000 140 64 60	7.21071.50.0
078 133 517 F	7.21798.83.0	001 540 00 97	7.21071.50.0
078 906 283 A	7.22687.07.0	001 540 08 97	7.21071.50.0
1H0 906 627	7.21903.70.0	001 540 14 97	7.21071.50.0
1H0 906 627 A	7.21903.75.0	001 540 15 97	7.21071.50.0
1J0 906 627	7.22903.01.0	001 540 20 97	7.21071.50.0
1J0 906 627 A	7.22903.04.0	001 540 35 97	7.21071.50.0
1J0 906 627 B	7.22903.02.0	001 540 70 97	7.21071.50.0
8E0 906 627 A	7.22903.19.0	001 540 86 97	7.21071.50.0
8E0 906 628 A	7.22903.18.0	002 540 18 97	7.22355.01.0
<b>BMW</b>		<b>OPEL</b>	
1 259 257	7.12977.51.0	17 112 023	4.07501.50.0
1 741 130	7.22341.08.0	17 112 027	4.07501.51.0
1 742 711	7.22340.63.0	17 112 031	4.07501.50.0
1 742 712	7.22341.08.0	17 112 712	4.07501.50.0
11 61 1 259 257	7.12977.51.0	58 51 010	7.22138.50.0
11 74 1 741 130	7.22341.08.0	58 51 019	7.22138.50.0
11 74 1 742 711	7.22340.63.0	58 51 039	7.21903.10.0
11 74 1 742 712	7.22341.08.0	817 253	4.07501.50.0
11 74 2 246 175	7.21903.73.0	817 254	4.07501.51.0
11 74 2 247 906	7.22796.01.0	817 255	4.07501.50.0
17 30 2 243 804	7.21911.83.0	838 078	7.20975.66.0
2 243 804	7.21911.83.0	838 082	7.20975.66.0
2 246 175	7.21903.73.0	857 201	7.22566.50.0
2 247 906	7.22796.01.0	857 204	7.22293.50.0
<b>CITROEN</b>		857 205	7.22449.02.0
1628 TV	7.28328.05.0	857 206	7.22293.03.0
9641 726680	7.28328.05.0	860 485	7.21903.12.0
9645 029180	7.28328.05.0	90 194 988	7.20975.66.0
<b>FIAT / IVECO</b>		90 502 750	7.22566.50.0
467 49 673	7.28148.01.0	90 530 039	7.22138.50.0
763 27 150	7.21493.50.0	90 530 479	7.22449.02.0
<b>FORD</b>		90 541 456	7.22293.50.0
1 003 802	7.21903.70.0	90 542 357	7.22138.50.0
1 003 803	7.21895.55.0	90 542 387	7.22449.02.0
1 031 090	7.21903.75.0	90 542 828	7.20975.66.0
95 VW12B573 BA	7.21895.55.0	90 573 434	7.22293.03.0
95 VW12B573 BB	7.21895.55.0	97 218 331	7.21903.10.0
95 VW12B573 CA	7.21903.70.0	97 219 155	7.21903.12.0
95 VW12B573 CB	7.21903.75.0	<b>PEUGEOT</b>	
<b>LANCIA</b>		1628 TV	7.28328.05.0
467 68 250	7.21903.48.0	9641 726680	7.28328.05.0
467 68 2500	7.21903.48.0	9645 029180	7.28328.05.0
		<b>ROVER</b>	
		ERR 3314	7.21903.50.0
		MSG 100110	7.21903.33.0



# CROSS REFERENCE

OE-No.		OE-No.	
<b>SEAT</b>			
028 906 283 A	7.21895.55.0		
028 906 283 F	7.21895.55.0		
028 906 283 J	7.21895.55.0		
1H0 906 627 A	7.21903.75.0		
1J0 906 627	7.22903.01.0		
<b>SKODA</b>			
028 906 283 A	7.21895.55.0		
028 906 283 F	7.21895.55.0		
028 906 283 J	7.21895.55.0		
028 906283 F	7.21895.55.0		
028 906283 J	7.21895.55.0		
1H0 906627 A	7.21903.75.0		
1H0 906 627 A	7.21903.75.0		
1J0 906 627	7.22903.01.0		
1J0 906627	7.22903.01.0		
<b>VAUXHALL</b>			
17 112 023	4.07501.50.0		
17 112 031	4.07501.50.0		
17 112 712	4.07501.50.0		
58 51 010	7.22138.50.0		
58 51 019	7.22138.50.0		
58 51 039	7.21903.10.0		
817 253	4.07501.50.0		
817 255	4.07501.50.0		
857 204	7.22293.50.0		
857 206	7.22293.03.0		
860 485	7.21903.12.0		
90 530 039	7.22138.50.0		
90 541 456	7.22293.50.0		
90 542 357	7.22138.50.0		
90 573 434	7.22293.03.0		
97 218 331	7.21903.10.0		
97 219 155	7.21903.12.0		
<b>VOLKSWAGEN</b>			
026 906 283 H	7.21704.50.0		
028 906 283 A	7.21895.55.0		
028 906 283 F	7.21895.55.0		
028 906 283 J	7.21895.55.0		
037 906 283 A	7.22402.50.0		
037 906 283 C	7.22880.01.0		
037 906 283 D	7.28098.04.0		
054 906 267	7.21483.54.0		
054 906 267 A	7.21483.54.0		
078 906 283 A	7.22687.07.0		
1H0 906 627	7.21903.70.0		
1H0 906 627 A	7.21903.75.0		
1J0 906 627	7.22903.01.0		
1J0 906 627 A	7.22903.04.0		
1J0 906 627 B	7.22903.02.0		
2D0 906 283 A	7.21071.50.0		
<b>VOLVO</b>			
12 66026	7.20271.52.0		
12 71630	7.21681.51.0		
30 618057	7.21903.44.0		
35 31086	7.21681.51.0		
618057	7.21903.44.0		
86 27299	7.22240.08.0		
91 35742	7.21980.50.0		
91 55936	7.22240.09.0		
94 70775	7.22517.04.0		
94 73212	7.22240.08.0		

CROSS REFERENCE





<b>(D)</b> Pierburg Nr.	<b>ALT → NEU</b>
<b>(GB)</b> Pierburg no.	<b>OLD → NEW</b>
<b>(F)</b> No. Pierburg	<b>ANCIEN → NOUVEAU</b>
<b>(E)</b> No. Pierburg	<b>ANTIGUO → NUEVO</b>
<b>(I)</b> N. Pierburg	<b>VECCHIO → NUOVO</b>





# PIERBURG-NO. OLD → NEW

old	new	old	new
5.33329.02.0	4.07501.52.0	7.21903.38.0	7.21903.10.0
5.33329.52.0	4.07501.52.0	7.21903.38.5	7.21903.10.0
7.07810.00.0	7.21071.50.0	7.21903.39.0	7.21903.12.0
7.07860.00.0	7.21071.50.0	7.21903.39.5	7.21903.12.0
7.12930.00.0	7.21071.50.0	7.21903.43.0	7.21903.44.0
7.12931.00.0	7.21071.50.0	7.21911.33.0	7.21911.83.0
7.12932.00.0	7.21071.50.0	7.21980.00.0	7.21980.50.0
7.12953.00.0	7.21071.50.0	7.22138.00.0	7.22138.50.0
7.12961.00.0	7.21071.50.0	7.22138.00.5	7.22138.50.0
7.12979.00.0	7.21071.50.0	7.22240.03.0	7.22240.09.0
7.12981.00.0	7.21071.50.0	7.22240.05.0	7.22240.08.0
7.12982.00.0	7.21071.50.0	7.22240.06.0	7.22240.08.0
7.20229.00.0	7.20229.50.0	7.22293.00.0	7.22293.50.0
7.20271.02.0	7.20271.52.0	7.22293.00.1	7.22293.50.0
7.20330.00.0	7.21071.50.0	7.22293.00.5	7.22293.50.0
7.20524.00.0	7.20524.50.0	7.22293.01.0	7.22293.03.0
7.20649.00.0	7.21071.50.0	7.22340.13.0	7.22340.63.0
7.20733.00.0	7.20733.51.0	7.22341.00.0	7.22341.08.0
7.20733.01.0	7.20733.51.0	7.22355.00.0	7.22355.01.0
7.20975.16.0	7.20975.66.0	7.22402.00.0	7.22402.50.0
7.21071.00.0	7.21071.50.0	7.22402.00.1	7.22402.50.0
7.21239.00.0	7.21239.50.0	7.22402.00.2	7.22402.50.0
7.21483.01.0	7.21483.54.0	7.22402.01.0	7.22402.51.0
7.21483.04.0	7.21483.54.0	7.22449.00.0	7.22449.02.0
7.21493.00.0	7.21493.50.0	7.22449.00.5	7.22449.02.0
7.21610.00.0	7.21704.50.0	7.22517.02.0	7.22517.04.0
7.21610.00.1	7.21704.50.0	7.22566.00.0	7.22566.50.0
7.21610.00.2	7.21704.50.0	7.22687.00.0	7.22687.07.0
7.21610.00.5	7.21704.50.0	7.22687.01.0	7.22687.07.0
7.21681.00.0	7.21681.51.0	7.22687.02.0	7.22687.07.0
7.21681.01.0	7.21681.51.0	7.22687.03.0	7.22687.07.0
7.21704.00.0	7.21704.50.0	7.22687.04.0	7.22687.07.0
7.21798.03.0	7.21798.83.0	7.22687.05.0	7.22687.07.0
7.21798.23.0	7.21798.83.0	7.22687.06.0	7.22687.07.0
7.21798.33.0	7.21798.83.0	7.22687.08.0	7.22687.07.0
7.21877.00.0	7.21681.51.0	7.22687.09.0	7.22687.07.0
7.21877.50.0	7.21681.51.0	7.22796.00.0	7.22796.01.0
7.21895.00.0	7.21895.55.0	7.22880.00.0	7.22880.01.0
7.21895.00.5	7.21895.55.0	7.22903.20.0	7.22903.01.0
7.21895.13.0	7.21895.55.0	7.22903.21.0	7.22903.16.0
7.21895.30.0	7.21895.55.0	7.22903.22.0	7.22903.17.0
7.21895.50.0	7.21895.55.0	7.22903.25.0	7.22903.04.0
7.21895.63.0	7.21895.55.0	7.22903.30.0	7.22903.18.0
7.21895.80.0	7.21895.55.0	7.22903.35.0	7.22903.19.0
7.21903.00.0	7.21903.50.0	7.22903.45.0	7.22903.02.0
7.21903.04.0	7.21903.73.0	7.28148.00.0	7.28148.01.0
7.21903.05.0	7.21903.75.0	7.28328.00.0	7.28328.05.0
7.21903.11.0	7.21903.48.0		
7.21903.15.0	7.21903.75.0		
7.21903.16.0	7.21903.10.0		
7.21903.20.0	7.21903.70.0		
7.21903.20.1	7.21903.70.0		
7.21903.20.2	7.21903.70.0		
7.21903.20.3	7.21903.70.0		
7.21903.20.5	7.21903.70.0		
7.21903.21.0	7.21903.49.0		
7.21903.21.1	7.21903.49.0		
7.21903.22.0	7.21903.51.0		
7.21903.22.1	7.21903.51.0		
7.21903.23.0	7.21903.73.0		
7.21903.25.0	7.21903.75.0		
7.21903.25.1	7.21903.75.0		
7.21903.25.2	7.21903.75.0		
7.21903.25.5	7.21903.75.0		
7.21903.26.0	7.21903.33.0		

PIERBURG-NO. OLD → NEW

# SCHADENSBERICHT

für PIERBURG - Produkte

# MOTOR SERVICE INTERNATIONAL



KOLBENSCHMIDT



PIERBURG

Ihre Reklamations-Nr:

MSI Reklamations-Nr:

Ihre Adresse (MSI Kunde):

Adresse Ihres Kunden (Werkstatt, Motoreninstandetzer):

## reklamiertes Teil:

<input type="checkbox"/>	AGR-Ventil	<input type="checkbox"/>	Sekundärluftpumpe	<input type="checkbox"/>	Leerlaufsteller		
<input type="checkbox"/>	el. Kraftstoffpumpe	<input type="checkbox"/>	el. Ventil	<input type="checkbox"/>	Sekundärluft-Ventil	<input type="checkbox"/>	Prüf-/Messwerkzeug
<input type="checkbox"/>	mech. Kraftstoffpumpe	<input type="checkbox"/>	Luftmassenmesser	<input type="checkbox"/>	Vakuumpumpe	sonst.: <input type="text"/>	

PIERBURG-Artikelnummer\*:

## Angaben zum Fahrzeug:

LKW / Bus     Oldtimer     stationär     landwirtsch. Fahrzeug  
 Flugzeug     PKW    Sonderfahrzeug:     sonst.:

Fahrzeug-Hersteller\*     Fahrzeug-Typ\*     Tag der Erstzulassung

Einbaudatum\* / km-Stand\* oder Betriebsstunden\*  /     Ausbaudatum\* / km-Stand\* oder Betriebsstunden  /

Grund der Beanstandung\*

Welche Reparaturmaßnahmen haben sie eingeleitet?\*

## Bitte beachten:

- Senden Sie uns bitte das komplette Bauteil mit einem vollständig ausgefüllten Schadensbericht ein, um Ihren Schaden objektiv beurteilen zu können (Adresse siehe unten).
- Die mit einem \* gekennzeichneten Felder sind Pflichtfelder. Um eine schnelle Abwicklung Ihres Antrages zu ermöglichen, sind diese Felder unbedingt auszufüllen!
- Die Bearbeitung ist nur dann möglich, wenn sie uns den Kaufbeleg (ggf. mit Nebenkosten) mit einsenden. Nachträglich eingereichte Belege über Nebenkosten können nicht ohne weiteres berücksichtigt werden.
- Für jedes reklamierte Bauteil ist ein gesonderter, vollständig ausgefüllter Antrag auszufüllen.

Sollen wir Ihnen die eingesendeten Teile im Falle einer Ablehnung zu Ihren Lasten zurücksenden? \*

ja

nein

Stadt/Land

Datum

Name

bitte senden an:

MSI Motor Service International GmbH, S-ZMT, Hamburger Str. 15, D-41540 Dormagen

# DIAGNOSING

for PIERBURG products

# MOTOR SERVICE INTERNATIONAL



KOLBENSCHMIDT



PIERBURG

Your claim no.

MSI claim no.

your name (MSI customer):

your customers name (workshop, engine reconditioner):

### claimed parts:

EGR valve     Secondary air pump     Idle controller  
 El. fuel pump     El. valve     Secondary air valve     Test/meas. equipment  
 Mech. fuel pump     Air flow sensor     Vacuum pump    Other:

### PIERBURG part no.\*:

### Vehicle details:

Truck / bus     Old timer     Stationary engine     Agricultural vehicle  
 Aircraft     Car    Special vehicle     Other:

Vehicle manufacturer\*     Vehicle type\*     Registration date

Installation date\*/km\* or operating hours\*  /     Removal date\* / km\* or operating hours\*  /

Reason for claim\*

What kind of repair did you try?\*

### Please note:

- Please return to us the complete component with a completely filled in DIAGNOSING Report so that we may objectively assess the damage you discovered. (Address see below.)
- The fields marked with an \* must be filled in. In order to be able to process your application faster, filling in of these fields is mandatory!
- Processing will only be possible if you provide the receipt (if required with additional costs) together with this form. Receipts relating to additional costs received later cannot be taken into account offhand.
- A completely filled in application must be provided for each component claimed about.

In case your complaint is rejected, shall we return the components we have received at your expense? \*

Yes

No

City/Country

Date

Name

Please send to:

MSI Motor Service International GmbH, S-ZMT, Hamburger Straße 15, D-41540 Dormagen

# RAPPORT DE RÉCLAMATION

pour les produits PIERBURG

# MOTOR SERVICE INTERNATIONAL



KOLBENSCHMIDT



PIERBURG

Votre N° de réclamation:  N° de réclamation MSI: Votre adresse (Client MSI):   
Adresse de votre client (atelier, rectifieur): 

**Pièce défectueuse:**

<input type="checkbox"/>	Valve EGR	<input type="checkbox"/>	Pompe air second.	<input type="checkbox"/>	Régleur de ralenti		
<input type="checkbox"/>	Pompe à carburant électrique	<input type="checkbox"/>	Electrovanne	<input type="checkbox"/>	Valve d'air second.	<input type="checkbox"/>	Outil. contrôle/mesure
<input type="checkbox"/>	Pompe à carburant mécanique	<input type="checkbox"/>	Débitmètre massique d'air	<input type="checkbox"/>	Pompe à vide	autre:	<input type="text"/>

Référence PIERBURG\*: 

**Indications véhicule:**

<input type="checkbox"/>	PL / Bus	<input type="checkbox"/>	Collection	<input type="checkbox"/>	Moteur stationnaire	<input type="checkbox"/>	Véhicule agricole
<input type="checkbox"/>	Avion	<input type="checkbox"/>	Tourisme	Véhicule spécial:	<input type="text"/>	autre:	<input type="text"/>

Constructeur\*  Type véhicule\*  Date de 1ère mise en service Date de montage\* / kilométrage\* ou heures de marche\*  /  Date de démontage\* / kilométrage\* ou heures de marche\*  / Cause de réclamation\*  
  
  
  
À quelles réparations avez-vous procédé ?\*  
  
  
  
**Veillez noter:**

- Veuillez nous envoyer la pièce complète avec un rapport de réclamation entièrement rempli, pour nous permettre de juger objectivement le dommage. (Adresse voir ci-dessous, s.v.p.)
- Les zones désignées par un \* doivent obligatoirement être remplies. Veuillez remplir impérativement ces zones pour permettre un traitement rapide de votre demande!
- Le traitement n'est possible que si vous nous transmettez la facture d'achat (éventuellement avec les coûts annexes). Les notes ultérieures concernant les coûts annexes ne pourront pas être prises en compte d'emblée.
- Veuillez remplir une demande complète pour chaque pièce sujette à une réclamation.

En cas de rejet de votre demande, voulez-vous que les pièces vous soient renvoyées à vos frais ?\*      oui       non

Ville, pays       Date       Nom 

Envoyer ce rapport à:  
MSI Motor Service International GmbH, S-ZMT, Hamburger Straße 15, D-41540 Dormagen

# INFORME DE DAÑOS

para los productos PIERBURG

## MOTOR SERVICE INTERNATIONAL



KOLBENSCHMIDT



PIERBURG

Su N° de reclamación:

N° de reclamación MSI:

Su dirección (cliente MSI):

Dirección de su cliente (taller, mecánico de motores):

### Pieza reclamada:

Bomba de combustible eléctrica

Bomba de combustible mecánica

Válvula de recirculación

Válvula eléctrica

Sensor de masa de aire

Bomba de aire secundario

Válvula de aire secundario

Bomba de vacío

Actuador del ralentí

Verificador/registrado

Otros:

### Referencia PIERBURG\*:

### Datos del vehículo:

Camión/Bus

Oldtimer

Estacionar

Vehículo agrícola

Avión

Turismo

Vehículo especial:

Otros:

Marca del vehículo\*

Tipo vehículo\*

Fecha de matriculación

Fecha montaje\* / kilometraje\* u horas de servicio\*  /

Fecha desmontaje\* / kilometraje\* u horas de servicio\*  /

Motivo de la reclamación\*

¿Qué reparaciones ha realizado?\*

### Sírvase observar:

- Sírvase remitirnos el componente completo con un informe de daños íntegramente complementado a fin de poder juzgar objetivamente sus daños. (Dirección vea abajo.)
- Los campos marcados con un \* son obligatorios. ¡Estos campos deben imprescindiblemente complementarse para facilitar una rápida tramitación de su solicitud!
- La tramitación es posible sólo si nos adjunta el justificante de compra (si fuese el caso, con gastos adicionales). Justificantes de gastos supletorios remitidos posteriormente no podrán considerarse sin más.
- Por cada componente reclamado debe adjuntarse una solicitud íntegramente complementada.

¿Deben devolverse a sus costas las piezas remitidas en caso de una negativa?\*

sí

no

Ciudad / País

Fecha

Nombre

Enviar a:

MSI Motor Service International GmbH, S-ZMT, Hamburger Straße 15, D-41540 Dormagen

# MOTOR SERVICE INTERNATIONAL



KOLBENSCHMIDT



PIERBURG

MSI Motor Service  
International GmbH

Hamburger Straße 15  
D-41540 Dormagen  
Phone +49 21 33-2 67-1 00  
Fax +49 21 33-2 67-1 11

Untere Neckarstraße  
D-74172 Neckarsulm  
Phone +49 71 32-33 33 33  
Fax +49 71 32-33 28 64

info@msi-motor-service.com  
[www.msi-motor-service.com](http://www.msi-motor-service.com)

#### Pierburg Komponenten, Module und Systeme

- Kraftstoffversorgung
- Unterdruckversorgung
- Luftversorgung
- Schadstoffreduzierung
- Steuerung und Regelung

#### Pierburg components, modules and systems

- Fuel supply
- Vacuum generation
- Air supply
- Emission control
- Control and regulation

#### Composants, modules et systèmes Pierburg

- Alimentation en carburant
- Génération de dépression
- Alimentation en air
- Réduction des émissions nocives
- Commande et régulation

#### Componentes, módulos y sistemas de Pierburg

- Alimentación de combustible
- Alimentación de vacío
- Alimentación de aire
- Reducción de substancias nocivas
- Mando y reglaje

#### Componenti, moduli e sistemi di Pierburg

- Alimentazione di combustibile
- Alimentazione di vuoto
- Alimentazione di aria
- Riduzione delle sostanze nocive
- Comando e regolazione

Pierburg-Vertretung · Distributor · Distributeur · Distribuidor · Distributore

MSI Motor Service Internateional GmbH  
Printed in Germany  
> Ersetzt 8.40002.49.0 <  
Order-No. 8.40002.64.0



4 028977 462245